

MODELS VC-6275/6175/6075
DIGITAL STORAGE OSCILLOSCOPES

OPERATION MANUAL

Hitachi Denshi, Ltd.

WARRANTY

This Hitachi Denshi, Ltd. product is warranted against defects in workmanship and materials. If any failure, resulting from a defect in either workmanship or material shall occur under normal use within THREE YEARS from the original date of purchase, such failure shall be corrected free of charge to the original purchaser by repair or, at Hitachi Denshi's sole option, replacement of the defective part or parts. No charge shall be made for labor or services performed during said THREE YEARS period providing the defective product is brought or sent prepaid to our Authorized Service Station. Hitachi Denshi, Ltd. will either repair or at its sole option, replace any part except for fuses, probes, lamps, batteries and other optional materials which are defective in either workmanship or material under normal and proper use.

This warranty does not cover equipment which has been tampered with in any way, or to damage caused by accident, negligence, alteration, or misapplication.

This product must be returned transportation prepaid, properly packed and insured. Hitachi Denshi, Ltd. bears transportation cost of the repaired product back to the purchaser.

This warranty applies only to the original purchaser.

NO OTHER WARRANTIES ARE EXPRESSED OR IMPLIED. HITACHI DENSHI, LTD. IS NOT LIABLE FOR CONSEQUENTIAL DAMAGES.

NOTES FOR A SAFETY OPERATION

Before operating the instrument, be sure to check the following items.

(1) Terms in this manual

WARNING: Indicates a possible injury to a body or danger to life if care is not taken as described.

CAUTION: Indicates possible damage to the instrument or other equipment if care is not taken as described.

(2) Symbols

DANGER: Indicates the part which may cause an injury to a body or danger to life.

 **DANGER:** Indicates the high voltage part in the oscilloscope.

 **CAUTION:** Indicates to read the applicable items in this manual.

 : Protective earth terminal

(3) Notes for operation

① Connection with the AC power source

The instrument is provided with the protective earth terminal and the three-line power cord and plug to be connected to the AC power source. The lead of the protective earth terminal is connected to the metallic part of the instrument.

Be sure to plug the power cord into an AC outlet provided with a protective earth terminal to avoid the risk of electric shock.

② Replacement of fuse

Use only specified fuses.

The instrument is protected by a 5A fuse on the primary side of the power supply.

When this fuse is blown out, contact your nearest Hitachi Denshi representative. Do not try to use any fuse other than the specified ones.

Otherwise, further damage may occur and this could be dangerous.

(IMPORTANT: Use only the fuse of same size and rating as specified.)

	Shape (Diameter x length) mm	Type
5 A	5.2 x 20	MT4-5A

③ Operation in gas

Do not use the oscilloscope in combustible gas or vapor to avoid possible explosion.

④ POWER switch

Before plugging in the AC cord, be sure to check that the POWER switch is set to OFF for protection of the instrument.

⑤ Removal of the chassis

To avoid the risk of electric shock, do not remove the chassis by yourself. Contact your nearest Hitachi Denshi representative.

NOTE

- o The instrument operates normally with the 90 to 250 V line voltage. If the line voltage is out of the above range (especially lower voltage), the normal operation may not be restored even after the correct line voltage is applied. Use the instrument within the specified line voltage. If an abnormal operation occurs, check the line voltage, turn off the power for a short time, and then turn it back on.

WARNING:

Do not remove the chassis cover since a high voltage presents inside the instrument. When parts inside the instrument need to be adjusted or replaced, contact your nearest Hitachi Denshi representative.

- o When the power is turned on, the built-in microprocessor automatically calibrates the time base and diagnoses the sweep circuit operation. After the calibration, the time base settings are initialized.

The displays "CALIBRATION" and "COMPLETED" appear to show the normal calibration and sweep circuit operation. If other displays such as "CALIBRATION FAILED AT CYCLE CKT" appear and the display remains even when the power is turned off and on, contact your nearest Hitachi Denshi representative.

NOTES:

- a) It will take approximately twenty seconds until the automatic diagnoses are completed after the power is turned on.
- b) When the power switch is turned on after storage at a low temperature, it takes some time before the circuit operation becomes stable.

If the "FAILED" display appears while the power is on, keep the power-on state for several minutes. Turn off the power, then turn it back on, and check that the "COMPLETED" display appears.

- c) The built-in microprocessor may misoperate when turning the power switch on/off rapidly. Avoid rapid toggling of the power switch and allow three seconds or more for toggling.
- d) In case of the VC-6275, do not press the SELECTOR and SINGLE switches in the STORAGE MODE section simultaneously. Otherwise, the maintenance mode is set. In case the maintenance mode is established accidentally, press the SELECTOR switch to release the mode. The maintenance mode is used only by the service person.

CONTENTS

1. FEATURES	1
2. COMPOSITION	3
3. PRECAUTIONS	4
4. OPERATION PANEL	9
5. PANEL DESCRIPTION	12
5.1 Front Panel Section A	12
(1) Power and CRT	12
(2) Vertical deflection system	13
(3) Horizontal deflection system	16
(4) Trigger system	22
(5) Miscellaneous	25
5.2 Front Panel Section B	26
(1) OPERATION mode switches	26
(2) DISPLAY SAVE switch	29
(3) LED's	33
5.3 Rear Panel	34
6. HOW TO PRODUCE THE TRACE	37
7. METHOD FOR CONNECTING SIGNALS	39
(1) Using probes	39
(2) Direct connections	41
8. BASIC OPERATIONS AND MEASUREMENT PROCEDURES	43
8.1 Data Display	43
(1) NON STORE mode display	43
(2) STORAGE mode display	46
8.2 NON STORE Mode	52
(1) Normal sweep display	52
(2) In the case of measuring a single waveform	53
(3) In the case of measuring two waveforms	54
(4) In the case of measuring a waveform in the X-Y mode	54

8.3	Digital Storage Functions	55
(1)	Normal storage mode (NORM)	55
(2)	Average mode (AVG)	56
(3)	Envelope mode (ENV)	57
(4)	ROLL mode	60
(5)	External sampling clock mode (EXT CLK)	61
(6)	HOLD mode	63
(7)	SAVE in the HOLD mode	64
(8)	Display of the save memory	66
(9)	Single operation in the HOLD mode	67
(10)	The PLOT output in the HOLD mode	69
(11)	Horizontal magnifying display	73
(12)	Interpolation	79
(13)	Battery back-up function	81
(14)	IC memory card	81
8.4	General Measurement	83
(1)	Voltage measurement	83
(2)	Time and frequency measurement	86
(3)	How to trigger	89
(4)	Measurement of the waveform before the trigger point	94
(5)	Operation of the AUTO range function	95
(6)	Operating procedure of the delayed sweep	96
(7)	Measurement of single shot phenomena	99
(8)	Operation of the BW LIMIT function (only valid for a trigger signal in the STORAGE mode)	100
(9)	System reset	101
9.	DIGITAL PLOT OUTPUT TO THE XY PLOTTER	102
9.1	Applicable XY Plotter	102
9.2	Specifications of Plot	102
9.3	Connection and Setting	103
9.4	Operation	106
9.5	Plotting Colors	106
9.6	Repetition of Plot Sequence	107
9.7	GPIB Interface	108
9.8	Major Causes of Troubles	108

10.	GPIB	109
10.1	Introduction	109
10.2	GPIB System	109
10.2.1	General	109
10.2.2	Specifications	110
10.2.3	Multiline interface message command	113
10.3	The GPIB for the Digital Storage Oscilloscope	115
10.3.1	GPIB functions	115
10.3.2	Address switch setting of the instrument	119
10.3.3	Operating functions and function commands	121
10.3.4	Format of transfer data	131
10.3.5	Delimiter	136
10.3.6	Processing of abnormal operation	136
10.4	Protocol	137
10.4.1	Switching of the command mode and the data mode	137
10.4.2	Address command	138
10.4.3	Universal command	138
10.4.4	Serial poll	139
10.4.5	Precaution for protocols	140
10.5	Caution on the Data Transfer Sequence	140
10.6	Connection and Operation of the Digital Storage Oscilloscope and the GPIB	140
10.7	Programming for Data Transfer	141
10.7.1	GPIB - Digital Storage Oscilloscope CONTROL PROGRAMMING 1	142
10.7.2	GPIB - Digital Storage Oscilloscope CONTROL PROGRAMMING 2	143
10.7.3	GPIB - Digital Storage Oscilloscope CONTROL PROGRAMMING 3	144
10.8	Major Causes of Abnormal Data Transfer	145
10.9	Programming Example	146
11.	OPTION	155
11.1	IC Memroy Card Reader/writer	155
11.2	Extension Interface	155
12.	SPECIFICATIONS	156

1. FEATURES

The Hitachi VC-6275, VC-6175, and VC-6075 are high-speed digital storage oscilloscopes provided with a high-speed A/D converter for each channel to enable the measurement, memory, and analysis of high-speed phenomena and an IC memory card can be used.

(1) High speed and wide bandwidth

A high-speed A/D converter is provided for each channel, and the input signal can be sampled at the following rates.

If the signal has a complete repetition, the signal of up to 100 MHz can be stored. Further this oscilloscope can be used as a normal 100 MHz real-time oscilloscope.

Model	Maximum sampling rate
VC-6275	200 Msps (at the one-channel sampling)
	100 Msps (at the two-channel sampling)
VC-6175	100 Msps (at the two-channel sampling)
VC-6075	50 Msps (at the two-channel sampling)

* Msps = Mega sampling per second

(This abbreviation is used throughout the operation manual.)

(2) Large memory capacity

Memory capacity is 4 kilo-words per channel.

Normally the waveform including all the 4 kilo-words data is displayed. Therefore, rapidly changing transient phenomena can be measured with high accuracy.

(3) Memory of waveforms (save function)

Two save memories of 4 kilo-words/waveform are provided in the instrument, and 15 save memories of 64k bytes, i.e., 4-kilo-words/waveform, are provided in the IC memory card. The waveforms stored in CH1 and CH2 can be stored up to 17 waveforms.

The waveforms stored is retained up to approximately 72 hours in the save memory of the instrument, and up to approximately 3 years in the IC memory card. The IC memory card is convenient for storing and comparing data. The card is easy to carry.

(4) Multiple functions

Multiple functions to analyze signals are provided.

- o Roll mode function: Facilitates the measurement of a low-speed signal.
- o Average function: Removes a noise component from the signal including random noises.
- o Envelope function: Detects a minimum of 100 ns glitches.

(5) Various output functions

Various output functions are built in to analyze and record storage data.

- o Analog output function to a pen recorder or an XY recorder
- o GPIB interface
Digital data is output to a personal computer, etc.
- o Digital plot function: A hard copy of the display on the CRT is directly obtained by the XY plotter via the GPIB.

(6) CRT readout, cursor read, and automatic measurement functions

The operation and the measurement can be made quickly.

- o CRT readout function : Displays the characters of the setting information of the operation panel on the CRT.
- o Cursor read function : Displays the voltage difference (ΔV), the time difference (ΔT), and the frequency ($1/\Delta T$) between cursors alphanumerically.

As for the stored waveform, the difference between the maximum and minimum voltages (V_{pp}), and the frequency (FREQ) are automatically measured.

(7) Extension interface bus

All the signals required for controlling the instrument from an external microprocessor are available.

Therefore, the functions of the instrument can be enhanced easy by connecting an external microprocessor.

2. COMPOSITION

(1) Oscilloscope, VC-6275, VC-6175, or VC-6075 1 unit

(2) Accessories

Probes, AT-10AP 1.5 2 pcs.

Fuse, 5 A (A spare fuse is inside the fuse holder of the oscilloscope) 1 pc.

IC memroy card 1 pc.

Dummy card 1 pc.

Operation manual 1 copy

AC power cord, 3-conductor 1 pc.

Dust cover 1 pc.

3. PRECAUTIONS

Installation

- * Avoid installing the instrument in an extremely hot or cold place.
 - o Avoid placing the instrument in a place exposed directly to sunlight for a long time, in a car in mid-summer, or near a room heating device.
 - o The maximum operating ambient temperature is 40°C.

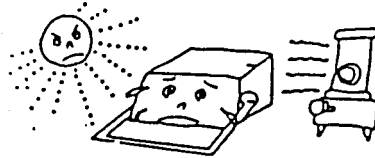

- * Do not use the instrument outdoors for a long time on a cold winter day. The operating ambient temperature is 0°C or more.



- * Avoid moving the instrument from a hot place to a cold place and vice versa, or condensation may form inside the instrument.

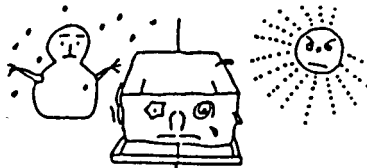

- * Keep the instrument away from damp air, water, and dust. Unexpected trouble may be caused when the instrument is placed in a damp or dusty place. The operating ambient humidity is 45 to 85%. Do not place a liquid-filled container on the instrument. An accidental intrusion of liquid may also cause troubles.

- * Do not place or use the instrument in a place subject to vibration.

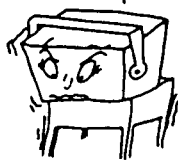

- * Do not place the instrument near a magnet or a magnetic body. An oscilloscope uses electron beams. Therefore, do not bring a magnet close to the instrument or do not use the instrument near an equipment generating strong magnetic force.



Operating considerations

- * Do not put a heavy object on the instrument.
- * Do not block ventilation holes.

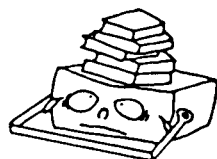

- * Do not apply a heavy shock to the instrument.



- * Do not insert a wire, pin, etc. through ventilation holes.



- * Do not drag the instrument with a probe connected.

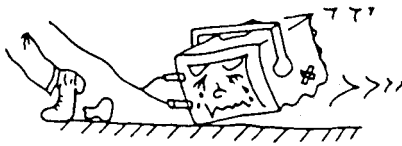

- * Do not leave a hot soldering iron on or around the cabinet or the screen.

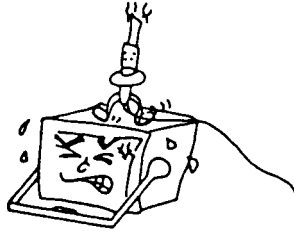

- * Do not try to turn the instrument upside down. Otherwise, knobs may be broken.

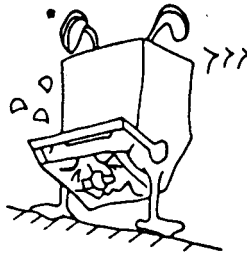

- * Do not use the instrument upright, leaving cables connected to terminals or connectors on the rear panel. Otherwise, the cables may be damaged.

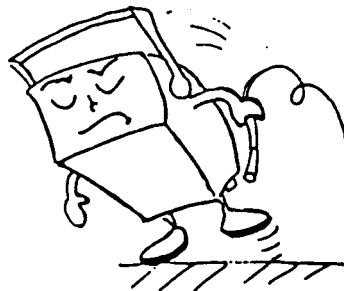

IC memory card

- * Do not insert any foreign thing other than the IC memory card and the dummy card. When the IC card memory is not in use, be sure to insert the dummy card instead.
 - * Check the inserting direction and the surface of the IC memory card before insertion.
- Do not apply excessive power when inserting the card.

* Do not remove the battery from the IC memory card unless the instrument is turned on with the card inserted. Otherwise, the data in the card is destroyed.

Be sure to replace the battery when the instrument is turned on with the IC memory card inserted correctly.

When not in use

When not in use, put the dust cover on the instrument.

Handle

Press in both pivot points of the handle and turn to the desired position.

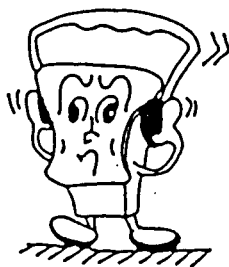

Care

* Removal of stain from the case

o When the outside of the case is stained, wipe it lightly using a neutral detergent and then clean the surface with a dry cloth.

* Never use a strongly volatile agent such as benzine and thinner.

o When the panel surface is stained, remove the stain with a clean, soft cloth. When heavy stains are present, first use a diluted detergent or alcohol and then clean with a dry cloth.



Maintenance

(1) Use and store the instrument carefully to avoid damage to built-in precise components.

(2) Clean the scale plate from time to time with a clean soft cloth.

(3) The recommended ambient condition is 20°C, 65%.

Calibration interval

To maintain the instrument accuracy, perform the calibration after each 1000 hours of operation, or every six months if used infrequently.

Operating precautions

* Check the line voltage.

The operating voltage range of this instrument is 90 to 250 V AC. Check the line voltage without fail before turning on the power switch.

* Do not increase the brightness too much.

Do not increase the brightness of the spot and trace too much. Your eyes may be tired and the phosphor screen of the CRT may be burnt.

* Do not apply an excessive voltage.

The maximum input voltages of connectors and probe are as follows.

INPUT direct	400 V (DC + AC peak max. 1 kHz)
When X 10 probe is used	500 V (DC + AC peak max. 1 kHz)
EXT BLANKING	30 V (DC + AC peak)
EXT CLK	5.5 V (DC)

CAUTION:

Never apply a voltage higher than specified to avoid possible damage to the instrument.

* Check that NON STORE, NORM, ENV or AVG switch is pressed.

Press one of the NON STORE, NORM, ENV and AVG switches during operation. (See Panel Layout in item 4 for switch positions.) The instrument does not operate properly unless the switch is pressed. Press one of the switches to bring the instrument to the desired operation.

4. OPERATION PANEL

The digital storage oscilloscope is provided with the real time oscilloscope function and the digital storage function. The front panel is designed to offer ease of operation, and the panel is composed of the Section A for setting of measurement conditions and of the Section B for setting of operation modes.

When the NON STORE switch of the Section B is selected, the instrument functions as a real time oscilloscope. This mode is called the NON STORE mode.

When a switch other than the NON STORE switch of the Section B is selected, the instrument functions as a digital storage oscilloscope. This mode is called the STORAGE mode. Refer to Item 5.2 (1) for the STORAGE mode.

Section A, Section B, and Rear panel are described below.

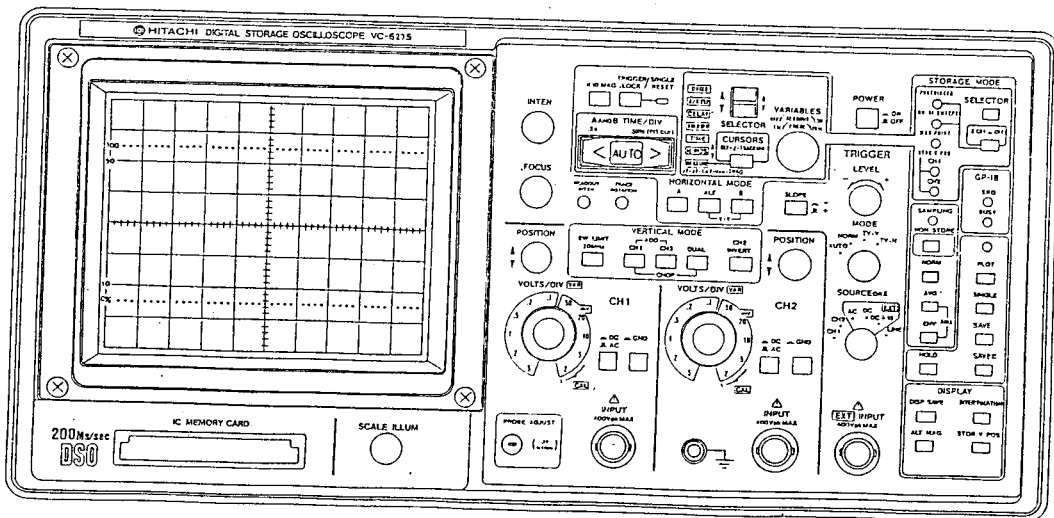

Fig. 4-1 (a) Front View (VC-6275)

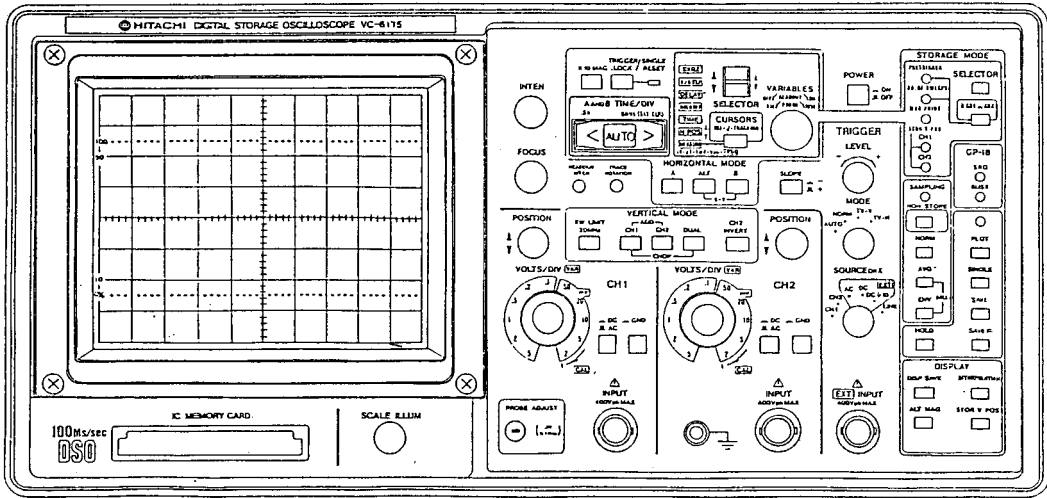

Fig. 4-1 (b) Front View (VC-6175)

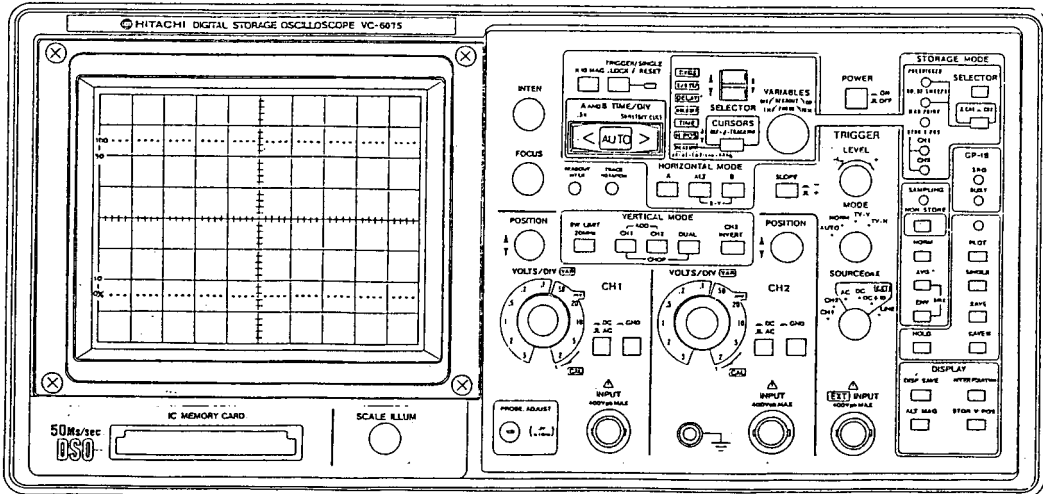
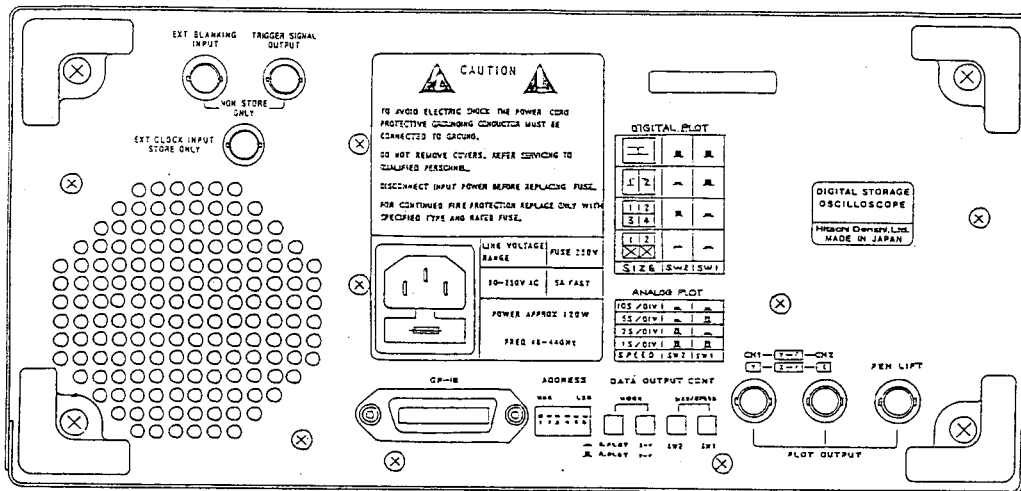
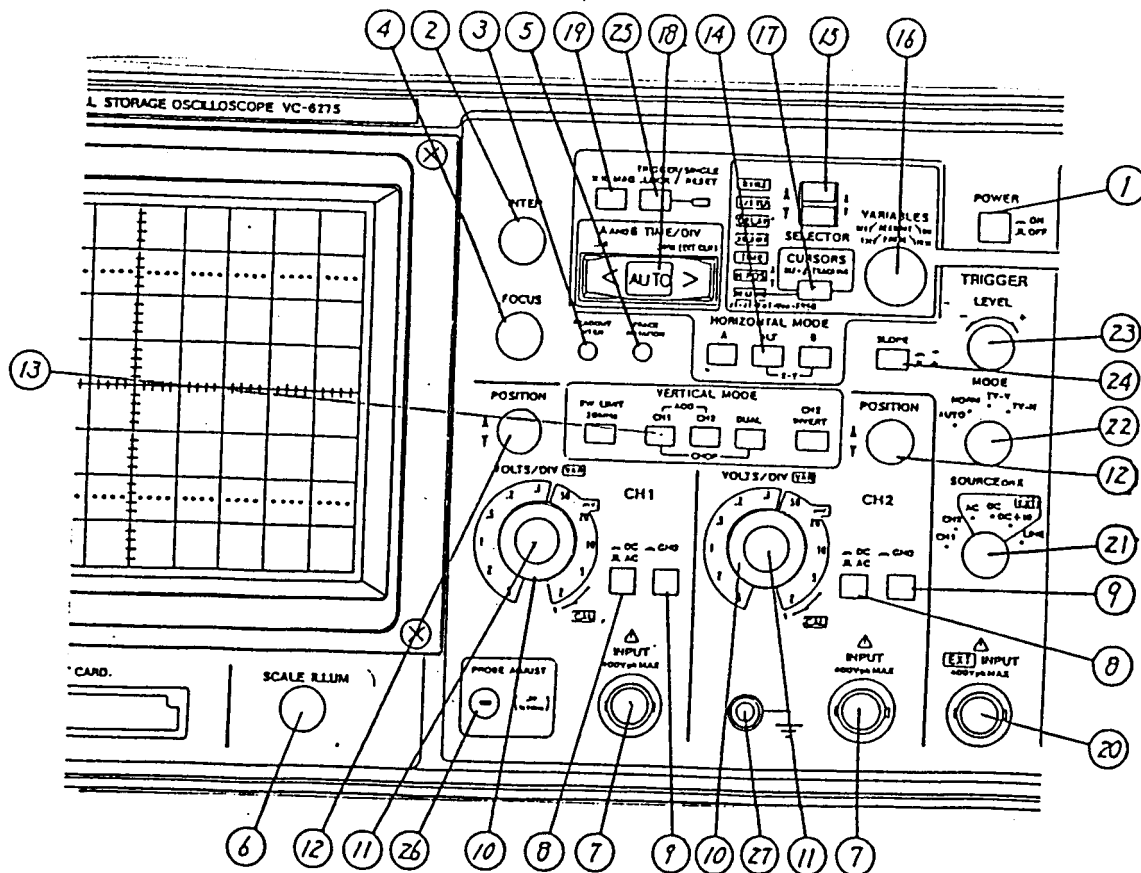

Fig. 4-1 (c) Front View (VC-6075)



5. PANEL DESCRIPTION

5.1 Front Panel Section A



(1) Power and CRT

(1) POWER switch

Power is ON in the pressed mode (), and OFF in the released mode ().

(2) INTEN control

This control adjusts the brightness of the waveform. A clockwise rotation increases the brightness.

③ **READOUT INTEN control (screwdriver adjustment)**

This control adjusts the brightness of the readout on the CRT. A clockwise rotation increases the brightness.

④ **FOCUS control**

After obtaining an appropriate brightness by the INTEN control, adjust the FOCUS control until the trace has best definition. Though the focus is corrected automatically when the INTEN control is rotated, adjust the FOCUS control if necessary.

⑤ **TRACE ROTATION control (screwdriver adjustment)**

This control corrects the displacement of trace caused by external magnetic fields. Align the trace with the horizontal graticule line with this control.

⑥ **SCALE ILLUM control**

This control controls the graticule illumination. A clockwise rotation increases the brightness. Adjust the illumination when viewing in a dark area or photographing.

(2) Vertical deflection system

⚠ ⑦ **INPUT connectors**

BNC connectors for CH1 and CH2 inputs.

⑧ **AC-DC switch**

When pressed in (■), the mode is set to the DC coupling. When pulled out (■), the mode is set to the AC coupling.

AC: Input signal is capacitively coupled to the vertical amplifier. The DC component of the input signal is blocked.

DC: All frequency components of the input signal are coupled to the vertical deflection systems.

⑨ GND switch

This is an input coupling select switch.

The input of the vertical amplifier is grounded in the pressed mode (■).

⑩ VOLTS/DIV switch

This is a step attenuator which selects the sensitivity.

Set to an appropriate range according to the incoming signal level.

⑪ VAR controls

* These controls provide a continuous variable vertical deflection factor. Attenuation of down to 1/2.5 is obtained by turning in a counterclockwise direction.

* These controls are useful when comparing two waveforms or when measuring the rise time of a square waveform.

* Normally set to the CAL position.

⑫ POSITION control

This is a control which adjusts the vertical position of the trace.

Clockwise rotation moves a trace upward, while counterclockwise rotation moves it downward.

NOTE:

In the CH2 INVERT mode, the above operation is reversed.

13 VERTICAL MODE switch

This switch selects the operation mode of the vertical system.

CH1: The signal applied to CH1 is displayed.

In the HOLD mode, the waveform stored in the CH1 memory is displayed.

In the PLOT output mode, the CH1 signal only is fed out.

CH2: Only the signal applied to CH2 is displayed.

In the HOLD mode, the waveform stored in the CH2 memory is displayed.

In the PLOT output mode, the CH2 signal only is fed out.

DUAL: The signals applied to CH1 and CH2 are displayed as a dual trace.

The display in the NON STORE mode is automatically selected by the TIME/DIV switch setting. When the TIME/DIV switch is set to 5 ms/DIV or slower, the CHOP mode is obtained. When the switch is set to 2 ms/DIV or faster range, the ALTERNATE mode is obtained.

In the STORAGE mode, each of the signals applied to CH1 and CH2 is sampled at the same timing, and the stored waveforms of the dual trace are displayed.

CHOP: When CH1 and DUAL are pressed simultaneously, this mode is set.

When this mode is selected in the NON STORE mode, the CHOP mode is selected even if the sweep range is set to the faster range. Input signals applied to CH1 and CH2 are switched at approximately 250 kHz regardless of the sweep, and displayed on the CRT. This mode is used in a faster range when it is required to measure a signal in the CHOP mode. This mode performs the same operation as that of DUAL in the STORAGE operation.

NOTE:

To prevent triggering from chopping transients, apply a triggering signal of a large level synchronized to the measuring signal to the EXT INPUT connector and set the TRIGGER SOURCE to EXT, or set the internal trigger level very appropriately.

ADD: The algebraic sum of CH1 and CH2 is displayed when both CH1 and CH2 switches are pressed.

In the STORAGE mode, the added waveform is stored in the CH1 memory, and the stored waveform is displayed.

In the HOLD mode, the signal waveform stored in the CH1 memory is displayed.

CH2 INVERT:

The polarity of the CH2 signal is inverted. It is recommended to use this function when comparing the waveforms with different polarities or when measuring the difference signal between CH1 and CH2.

BW LIMIT (only valid for a trigger signal in the STORAGE mode):

When this switch is pressed, the bandwidth is reduced to approximately 20 MHz and the measurement is made by eliminating undesired high frequency signals from the waveform. The high frequency component over 20 MHz is also eliminated from the trigger signal.

(3) Horizontal deflection system**⑭ HORIZONTAL MODE switch**

Selects the operation mode of the horizontal deflection.

A: Main sweep (A) appears on the CRT.

This setting is used in normal cases.

ALT: Both the main sweep (A) and the delayed sweep (B) are displayed.

In the STORAGE mode, the operation is the same as that in the A mode, and the sampling is performed at the speed corresponding to the A sweep time range.

B: The delayed sweep (B) appears on the CRT. The sweep time is controlled by the B time base.

In all the STORAGE modes other than the ROLL mode, the B sweep sampled at the speed corresponding to the B sweep time range is displayed when the A sweep time is from 2 μ s/DIV to 0.5 s/DIV.

X-Y: When the ALT and B switches are pressed simultaneously, an X-Y operation is available.

⑮ SELECTOR switch

This switch selects a parameter switch function related to the horizontal axis or a cursor measurement function.

Move the SELECTOR switch lever upward (Δ) or downward (∇) until the desired function lamp lights. Then adjust the VARIABLES control ⑯ appropriately.

NOTE:

The following functions can be selected either in the NON STORE mode or the STORAGE mode. Moreover, in the STORAGE mode, the functions described in ④② can be selected by the SELECTOR switch ④② on the STORAGE MODE section (Front panel B section). In this case, all the lamps of the following functions go off. Use this switch to select the following functions.

SINGLE: Displays the main sweep (A) once. (Only in the NON STORE mode.)

A/B SEP: Adjusts the vertical position of the delayed sweep (B) in the ALT sweep mode. (Only in the NON STORE mode)

- DELAY:** Used to set the delay time of the delayed sweep (B) starting point with respect to the main sweep (A) starting point. The delay time is displayed on the upper left side of the CRT and the B sweep window is indicated by the cursors.
- HOLDOFF:** Rotate the HOLDOFF control to obtain stable triggering for a complex signal, a high-frequency signal, an irregular signal, etc. The holdoff value is set to the minimum when the power is turned on or when the A TIME/DIV switch (18) is operated.
- TIME:** Adjusts the sweep speed of the main sweep (variable) (A) continuously. When the control is turned fully clockwise, the sweep speed is calibrated to the specified value (CAL state). Normally, set to the fully clockwise position (A = on the CRT). The variable time is set to the CAL state when the power is turned on or when the A TIME/DIV switch is operated. (Only in the NON STORE mode)
- H POS:** This switch moves a trace to the horizontal direction. Clockwise rotation moves a trace to the right side. Counterclockwise rotation moves a trace to the left side.
- MEASURE:** In this mode, ΔV , ΔT , $1/\Delta T$ Vpp, and FREQ can be selected and displayed in turn on the CRT by pressing the SELECTOR switch, and measurements by cursors and automatic measurement are available. However, the automatic measurement functions Vpp and FREQ are selectable only in the STORAGE mode.
- ΔV :** Two horizontal cursors appear. The voltage between the two cursors is calculated according to the setting of VOLTS/DIV, and displayed with ΔV on the upper side of the CRT.
- ΔT :** Two vertical cursors appear. The time between the two cursors is calculated according to the setting of TIME/DIV, and displayed with ΔT on the upper side of the CRT.

1/ Δ T: Two vertical cursors appear. The reciprocal of the time (frequency) between the two cursors is calculated according to the setting of TIME/DIV, and displayed with 1/ Δ T on the upper side of the CRT.

Vpp: An absolute value of the difference between the maximum and minimum voltages of the waveform of CH1 or CH2 displayed on the CRT is displayed on the upper side of the CRT.

FREQ: The frequency for the trigger signal source selected by the TRIGGER SOURCE or X switch is measured, and the measured value is displayed on the upper side of the CRT with the FREQ display.

NOTE:

Since the FREQ measurement is interlocked with the trigger, the FREQ is not measured when the signal is not triggered or the input signal is less than 25 Hz. At this time "FREQ...." is displayed.

①6 VARIABLES control

This control sets the function selected by the SELECTOR **①5**. Clockwise rotation moves the trace upward (\uparrow) or rightward (\rightarrow). Counterclockwise rotation moves the trace downward (\downarrow) or leftward (\leftarrow).

A combination use with the SELECTOR can blank the readout on the CRT and calculate values of the 1X and 10X modes of a probe. (For details, refer to section 8.1 sub section (2)).

①⑦ CURSORS REF·Δ·TRACKING control

REF: Moves the reference cursor on the CRT. (∇ or is displayed on the reference cursor.)

Δ: Moves the measuring cursor on the CRT. (∇ or is displayed on the measuring cursor.)

TRACKING: Simultaneously moves the reference cursor and the measuring cursor with the interval between the two cursors unchanged. (∇ or is displayed at the two cursors.)

①⑧ A AND B TIME/DIV switch

This switch sets the sweep time of the main sweep (A) and the delayed sweep (B), and the EXT CLK mode. The sweep is set by the HORIZONTAL MODE switch ①④ and the TIME/DIV setting data is displayed on the CRT.

In each operation mode, the following sweep time is selectable.

* NON STORE mode:

A sweep time: 50 ns/DIV to 0.5 s/DIV (22 steps)

B sweep time: 50 ns/DIV to 50 ms/DIV (19 steps)

A TIME/DIV \geq B TIME/DIV

* NORM and AVG modes:

A sweep time: 50 ns/DIV to 0.5 s/DIV (22 steps)

B sweep time: 2 μ s/DIV to 50 ms/DIV (14 steps)

A TIME/DIV \geq B TIME/DIV

NOTES:

- a) Only a completely repetitive signal can be stored in each range from 50 ns/DIV to 1 μ s/DIV of the A sweep time (repeat mode range). When a signal containing a non-repetitive component is stored in these ranges, the waveform different from the input signal may be displayed or the waveform on the CRT may not be updated with the sampling lamp lit.

In case of measuring a non-repetitive signal, set the range to 2 μ s/DIV or slower.

(b) The B sweep time can not be set to the position faster than 2 μ s/DIV. When the A sweep time is set to the repeat mode range of 50 ns/DIV to 1 μ s/DIV and the HORIZONTAL MODE is set to B, the A and B sweeps are automatically changed to 2 μ s/DIV.

* ENV mode:

A sweep time : 0.1 ms/DIV to 0.5 s/DIV (12 steps)

B sweep time : 0.1 ms/DIV to 50 ms/DIV (9 steps)

A TIME/DIV \geq B TIME/DIV

* ROLL mode:

A sweep time : 0.1 s/DIV to 50 s/DIV (9 steps)

The sweep rate is the same in any of the horizontal mode of A, ALT, or B.

AUTO

When the center of the TIME/DIV switch is pressed, the AUTO lamp lights, and the input signal is detected. Then the time range is changed automatically, and the waveform of approximately 1.6 to 4 cycles is displayed on the CRT. (But when the input signal is lower than 100 Hz or not triggered properly, the time range is set to 5 ms/DIV. When the signal is higher than approximately 8 MHz, the time range is set to 50 ns/DIV, the highest speed range.) Moreover, the time range automatically follows the change of the input signal. Refer to item 8.4 (5) for details.

EXT CLK

The EXT CLK mode is selectable only in the NORM or AVG mode. (Refer to item 8.3 (5) for detail.)

When the TRIGGER LOCK switch has been pressed, or the HORIZONTAL MODE switch is set to ALT or B, the EXT CLK mode is not selected even in the NORM or the AVG mode.

①9 X10 MAG switch

This switch is used to magnify A and B sweeps by 10 times. In this case, the sweep time is 1/10 times the value indicated by TIME/DIV. In the NON STORE mode, bring the portion of the waveform to be magnified to the center of the CRT by the H POS control. Then press the X10 MAG switch to magnify the waveform in the horizontal direction. In the STORAGE mode, the storage waveform at 1 division from the MAG point marker is magnified by 10 times in the horizontal direction.

(4) Trigger system

②0 EXT INPUT connector

This is a BNC connector for an external trigger signal, an external sweep signal, or an external X input.

②1 TRIGGER SOURCE OR X switch

In the NON STORE mode, this switch selects the trigger signal source or the X signal for an XY operation.

In the STORAGE mode, this switch selects only the trigger signal source. (The CH1 signal becomes the X signal for an XY operation in the STORAGE mode.)

CH1: The signal fed to CH1 is used as a signal source.

CH2: The signal fed to CH2 is used as a signal source.

EXT AC: The signal fed to EXT INPUT is used as a signal source after the DC component and the very low frequency component are removed.

EXT DC: The signal fed to EXT INPUT is used as a signal source as is. This signal is used when affecting synchronization to a very low frequency.

EXT DC:10:

The signal fed to EXT INPUT is attenuated to 10:1 and used as a signal source. This signal is used when affecting synchronization to a very low frequency.

LINE: Used to measure the signal synchronized to a line frequency.

22 TRIGGER MODE switch

AUTO: A sweep is performed automatically. When a trigger signal is applied, the normal sweep operation is performed and the waveform is stationary.

The instrument will automatically display a trace without an input signal being applied or out of trigger. This setting is convenient in most cases.

Normal trigger will be established by setting trigger level when a signal is applied to the input.

In the STORAGE operation, a waveform displayed on the CRT continues to be updated regardless of the presence of a trigger signal.

The trigger level automatically corresponds to the amplitude of the incoming signal and the signal is easily triggered.

NORM: Trace will appear when a sweep is triggered. Trace will not appear when a signal is not applied or when a signal is triggered properly. Use this MODE when effecting synchronization to a very low frequency signal (30 Hz or less) or for arming a single sweep. When the signal is not triggered properly in the STORAGE operation, a waveform is not updated and the traces are held.

TV-V: Used when measuring the vertical TV signal.

TV-H: Used when measuring the horizontal TV signal.

②③ TRIGGER LEVEL control

By controlling the trigger level, the sweep start point of the waveform is set.

Trigger LEVEL

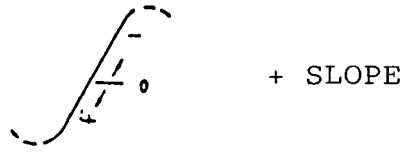

②④ SLOPE switch

This switch selects the slope of the signal that triggers the sweep. When the switch is pressed in (), sweep is triggered from the negative-going slope of the trigger signal. When the switch is pulled out (), sweep is triggered from the positive-going slope of the trigger signal,

+ SLOPE

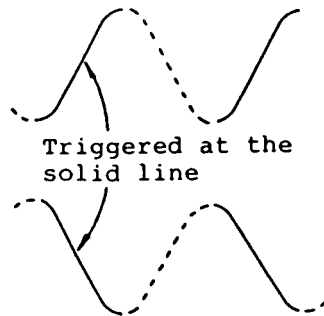

②⑤ TRIGGER LOCK/SINGLE RESET

When SINGLE is not selected by the SELECTOR switch (15) :

When the TRIGGER LOCK switch is pressed and the lamp is lit, the triggering state before the lamp is lit is held. If the TRIGGER LOCK switch is pressed with the triggering executed before the lamp is lit, and the stable triggering is ensured when the sweep time and the variable time are changed.

When **SINGLE** is selected by the SELECTOR switch (15) :

When the SINGLE RESET switch is pressed and the lamp is lit, the single sweep is armed.

NOTE:

When the TRIGGER MODE switch is set to AUTO, the sweep is performed once by pressing this switch, asynchronously with the incoming signal. Usually the single sweep function is used in conjunction with NORM triggering to detect and trigger on abnormalities, aberrations, or one time events.

(5) Miscellaneous

(26) **PROBE ADJUST terminal**

A 0.5V, 1 kHz square wave signal is available. This terminal is used for probe calibration.

(27) **GND terminal** ($\frac{\perp}{\equiv}$)

Grounding terminal

5.2 Front Panel Section B

(1) OPERATION mode switches

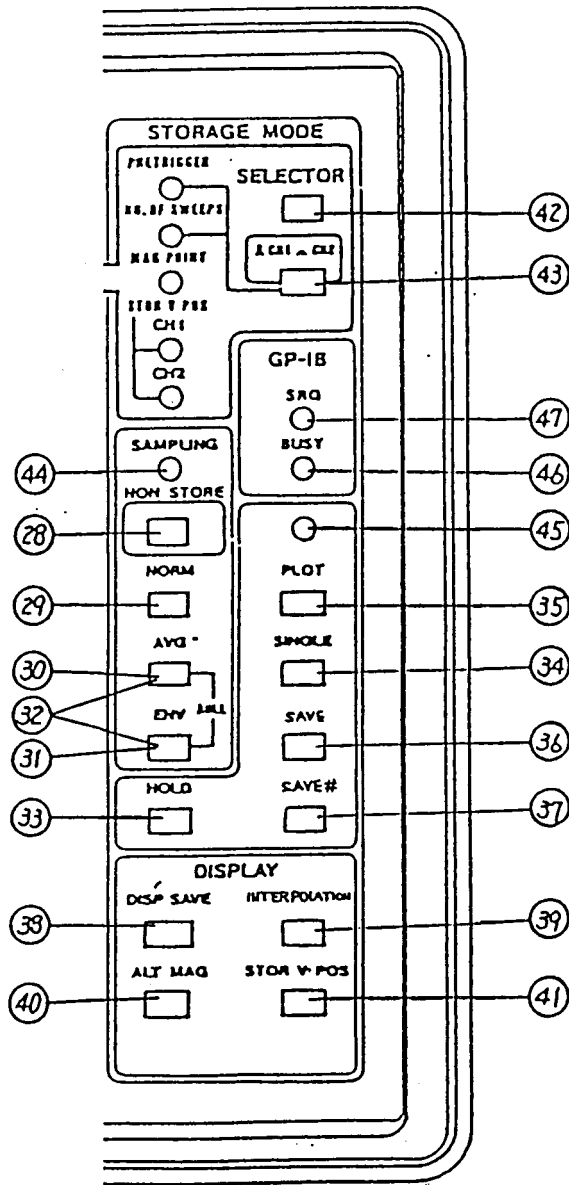

②8 NON STORE switch

When the NON STORE switch is pressed, the instrument functions as a conventional oscilloscope.

②9 NORM switch

When the NORM switch is pressed, the normal storage mode is established, and the instrument functions as a storage oscilloscope.

③0 AVG switch

A selected number of sweeps is stored and averaged. Then the resultant waveform is displayed.

③1 ENV switch

When this switch is pressed, the waveform envelope is displayed. The pulse waveform with more than 100 ns width is measured at a slow sweep time range.

③2 ROLL switch

When the AVG and ENV switches are pressed simultaneously, the ROLL mode is established. The old stored waveform is shifted to the left, and the new data is added to the right side of the old stored waveform. As a result, the waveform displayed on the CRT appears as if it flows from right to left.

The following switches are valid only when any of the switches ②9 to ③2 is pressed (in the STORAGE mode).

③③ **HOLD switch**

When this switch is pressed with the operation mode at NORM, AVG, ENV, or ROLL, a waveform on the CRT is not updated, but held.

③④ **SINGLE switch**

When this switch is pressed while the HOLD switch is being pressed with the operation mode at NORM, AVG, or ENV, the designated operation mode is executed only once, and the displayed waveform is updated. Then the resultant waveform is held.

③⑤ **PLOT switch**

This switch is valid only in the HOLD mode.

Press this switch in case of recording the displayed waveform data on the chart recorder, or the XY recorder as an analog signal, or the displayed contents on the XY plotter through the GPIB. When the switch is pressed again during plotting, the recording stops.

③⑥ **SAVE switch**

This switch is valid only in the HOLD mode.

With this switch, the waveform of the channel selected by the VERTICAL MODE switch is transferred and held in the save memory selected by the SAVE# switch.

③⑦ **SAVE# switch**

This switch is valid only when the HOLD DISP SAVE switch is pressed.

With this switch, the save memory A or B in the instrument or the save memory 1 to 15 in the IC memory card is selected.

Each pressing this switch changes the save memory as in the following order.

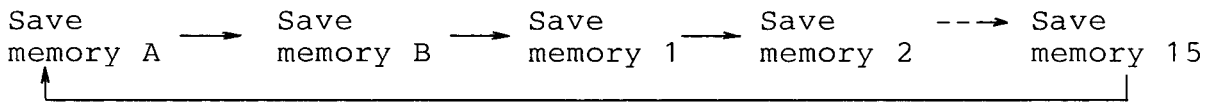

(For details of the retention of the waveform data and the selection of the save memories. Refer to item 8.3 (9).)

(2) DISPLAY SAVE switch

38 DISP SAVE switch

This switch is valid only in the NORM, ENV or HOLD mode.

When this switch is pressed in, the waveform of the save memory selected by the SAVE[#] switch is displayed on the CRT.

When the VERTICAL MODE switch is set to CH1 or ADD, the waveform of the save memory is displayed on CH2. When the VERTICAL MODE switch is set to CH2, the waveform of the save memory is displayed on CH1. When the VERTICAL MODE switch is set to DUAL or CHOP, the two waveforms of the serial save memory numbers are displayed on CH1 and CH2.

NOTE:

When the DISP SAVE switch is turned to off after the HOLD and the DISP SAVE switches are turned to on to display the waveform of the save memory, the waveform remains displayed.

This feature is convenient to copy and edit the waveform.

(For details of the waveform display of the save memory, refer to item 8.3 (10).)

39 INTERPOLATION switch

The linear and sine interpolations are available.

The interpolations are performed only to the magnified waveform in the HOLD mode. The procedures for interpolation are different for the NORM MAG and the ALT MAG modes.

In case of the NORM MAG mode

After interpolation is performed once, it is impossible to change the magnification ratio or return to the initial waveform.

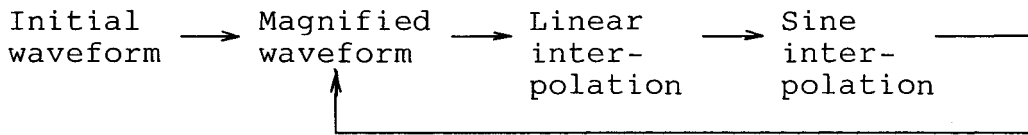

In case of the ALT MAG mode

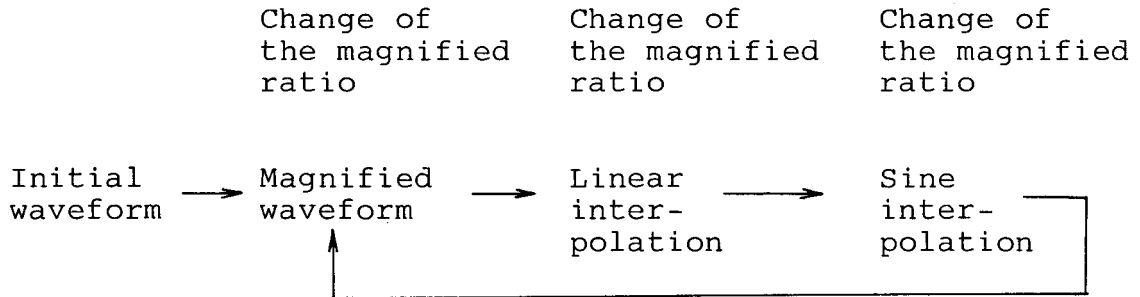

NOTE:

Execution of interpolation destroys the waveforms of save A and save B because the memories of save A and save B are used for the operation of interpolation. When the waveforms of save A and save B are required to retain, they must be transferred to the IC card memory before the execution of interpolation. For details, refer to NOTES of item 8.3 (12) before the execution of interpolation.

40 ALT MAG switch

When the horizontal magnify function is activated with this switch pressed, the non-magnified and the magnified waveforms are displayed simultaneously.

When CH2 of the VERTICAL mode is selected, this magnified waveform is displayed instead of the waveform of CH1 with the initial non-magnified waveform of CH2 being displayed.

When the VERTICAL mode is set to the position other than CH2, the magnified waveform of CH1 is displayed instead of the waveform of CH2. (The initial waveform of CH2 disappears.)

④1 STOR V POS switch

When this switch is pressed in, the display position of the storage waveform can be moved to the vertical direction. The display position can be moved by turning the VARIABLES control after the STOR V POS setting mode is selected by the SELECTOR switch.

④2 SELECTOR switch (for STORAGE MODE)

This switch is used when the VARIABLES control is used for the setting of the storage measurement conditions.

When this switch is pressed in, all the LED's arranged at the left side of the VARIABLES control ①6 go off, and the LED at the immediate left side of this switch lights.

Then, every time this switch is pressed in, the lighting position of the LED changes. Therefore, press this switch repeatedly until the LED intended to be lit lights. After that, the variable amount is set by the VARIABLES control ①6.

PRETRIGGER: Displays a marker displaying the position of a trigger point and a pretrigger amount (DIV unit) on the CRT. When the VARIABLES control is turned clockwise, the position of a trigger point moves to the right. When it is turned counterclockwise, the position moves to the left.

However, in the repeat mode range from 50 ns/DIV to 1 μ s/DIV, the trigger position is fixed at 0 DIV, and can not be moved.

In the ROLL mode, a PRETRIGGER display does not appear.

NO. OF SWEEPS: Displays the AVG number of the averaged sweeps on the CRT. The number of 2 to the nth power (n:1-8) is selected by the VARIABLES control.

MAG POINT: Displays the marker displaying the beginning point of the magnifying range and the position data on the CRT.

The waveform is magnified from the point of the initial waveform corresponding to this marker in the horizontal magnifying mode.

When the VARIABLES control is turned clockwise, the beginning point moves to the right. When it is turned counterclockwise, the beginning point moves to the left.

STOR V POS CH1: Moves the display position of the CH1 storage waveform to the vertical direction.

When the VARIABLES control is turned clockwise, the position moves upward. When it is turned counterclockwise, the position moves downward. (Valid only when the STOR V POS switch (41) is set to ON.)

STOR V POS CH2: Moves the display position of the CH2 storage waveform to the vertical position. (Valid only when the STOR V POS switch (41) is set to ON.)

④3 ■ CH1 and ■ CH2 switch

This switch selects the parameter of a waveform to be displayed on the CRT in the storage mode. When this switch is at CH1, the parameter of the CH1 waveform is displayed on the CRT. When this switch is at CH2, the parameter of the CH2 waveform is displayed on the CRT. The parameters to be displayed are PRETRIGGER, NO. OF SWEEPS, DELAY and MEASURE, which are displayed on the CRT according to the switch selection.

NOTES:

- a) When the waveform selected by this switch is not displayed, the four parameters are not displayed either.
- b) Since the **FREQ** measurement is performed for the signal selected by the **TRIGGER SOURCE** OR **X** switch, this switch is not valid.

(3) LED's

④④ SAMPLING LED (red)

This LED lights to indicate that the instrument is sampling data.

④⑤ PLOT/SINGLE/SAVE

When one of the switches ③④ to ③⑥ is pressed, this LED lights during its processing.

When the processing finishes, the LED goes off.

④⑥ BUSY LED (red)

This LED lights to indicate that the built-in micro-processor is busy with the communication with the GPIB and can not accept the switch data.

④⑦ SRQ LED (green)

This LED lights when the instrument is feeding the SRQ (service request) signal during the communication with the GPIB.

5.3 Rear Panel

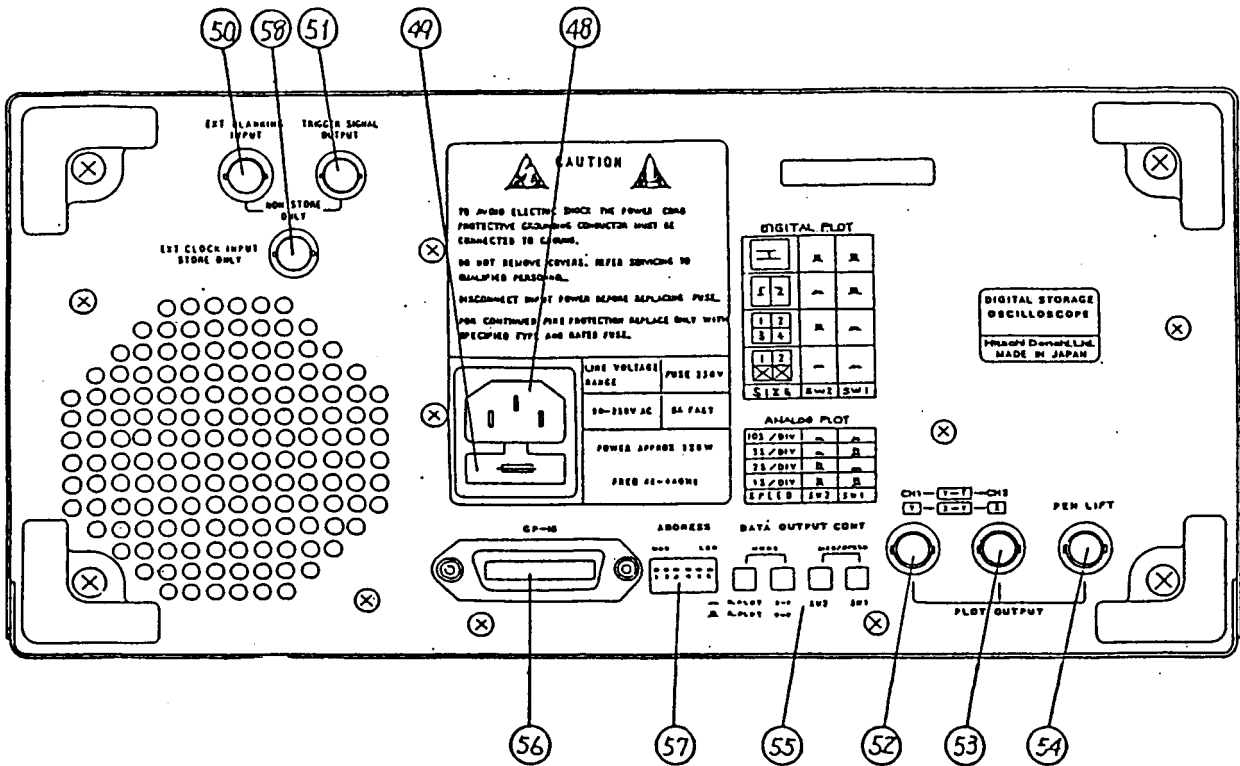

Fig. 5-3 Rear panel

④8 AC input connector

Connect the AC power source.

④9 FUSE

The fuse is inside the fuse holder.

CAUTION:

When the fuse is blown out, contact your nearest Hitachi Denshi representative.

50 EXT BLANKING INPUT terminal

This is a terminal for applying a blanking signal from an external source. This terminal is DC-coupled. The intensity is lowered by a positive signal, while it is increased by a negative signal.

51 TRIGGER SIGNAL OUTPUT connector

The signal selected by the TRIGGER SOURCE or X control **21** is available.

52 PLOT OUTPUT (CH1) BNC connector

CH1 data is fed out from the Y-T output (pen recorder output). For the X-Y output (X-Y recorder output), the selected data of CH1 or CH2 is fed out according to the selection of the VERTICAL MODE switch.

53 PLOT OUTPUT (CH2) BNC connector

For the Y-T output (pen recorder output), CH2 data is fed out. For the X-Y output (X-Y recorder output), the X-axis sweep signal is fed out.

54 PLOT OUTPUT (PEN LIFT) BNC connector

This connector is used to feed out the PEN LIFT signal for the recorder with the remote pen lift function.

PEN UP : High level (2.0 V or more)

PEN DOWN: Low level (0.8 V or less)

55 DATA OUTPUT CONT switch

This switch selects either analog or digital plot mode, selects either Y-T or X-Y output and the plot speed in the analog plot mode, and sets the plot size in the digital plot mode.

56 GPIB connector

Connect other equipment with GPIB interface.
The interface conforms to the IEEE-488 (1978) standards.

57 GPIB switches

These switches select the address of the instrument with the binary data by setting the five switches (2nd to 6th). The first switch is not used.

58 EXT CLOCK INPUT connector

This is an input connector for the external sampling clock.

6. HOW TO PRODUCE THE TRACE

At first, verify that the AC supply voltage is within the specified range.

Then connect the power cord on the rear panel to an AC outlet and set the controls as follows.

NON STORE	:	Pressed mode
GND	:	<u> </u> (Pressed mode)
POSITION	:	Midrange
HORIZONTAL MODE	:	A
TRIGGER MODE	:	AUTO
VERTICAL MODE	:	CH1

After completion of the above settings, turn on the POWER switch. The LED's on the front panel light for a while, and soon unnecessary LED's go off. When the INTEN control is turned clockwise, the trace appears. For immediate measurement, adjust the FOCUS control to obtain the sharpest possible trace.

Align the GND trace with the horizontal graticule line at the center of the screen by operating CH1 POSITION control. In some cases, the trace may be slightly oblique to the scale by the effect of earth magnetism.

In this case, align the trace with the horizontal graticule line at the center of the screen by properly adjusting the TRACE ROTATION control (screwdriver adjustment) on the front panel.

When this instrument is not in use, with power supplied, rotate the INTEN control counterclockwise to decrease the intensity. This protects the CRT from burning and prolongs its life.

NOTES:

For normal operation, the following function must be set to the 'CAL' position.

VOLTS/DIV VAR: Rotate fully clockwise. In this case, the VOLTS/DIV is calibrated to the indicated value and is changed from the UNCAL display " > " to the calibration display "Blank".

TIME/DIV VAR: Set the TIME by the SELECTOR (15), and turn the VARIABLES control clockwise until A = is displayed on the CRT.
The variable time is initialized when the power is turned on or when the time range of the A sweep is changed. At this time, the A TIME/DIV is calibrated to the indicated value.

7. METHOD FOR CONNECTING SIGNALS

The first step of measurement is to connect the signal to the instrument properly. Do it with utmost care.

WARNING:

When connecting the probe or the signal input cable to the circuit to be measured, be sure to connect the ground side of the probe or the signal input connector to the ground side of the signal source.

If not, potential difference between the instrument and other equipment or earth ground may result in shock hazard and damage the instrument, the probe, and other equipment.

(1) Using probes

Use the supplied probe when measuring a high frequency signal.

Supplied probe: AT-10AP1.5

When the X10/X1 switch on the probe is set to X10, the input signal is attenuated by this probe to 1/10.

This position is convenient to measure a large signal because a measuring range is expanded, though the position is inconvenient for a small signal.

When the input signal level is so low as not to be measured at the X10 position setting, the switch must be set to X1.

In this case, the input impedance is different and the measurable frequency bandwidth becomes extremely low. (For further details, refer to the operation manual of the supplied probe.)

NOTES:

- a) Do not apply a signal in excess of 500 V (DC + peak AC at 1 kHz or less) to the input.
- b) Connect the probe ground lead as close as possible to the point being measured especially when measuring a signal with a fast rise time or a high frequency signal. Long probe ground leads may cause waveform distortions, such as ringing and overshoot.

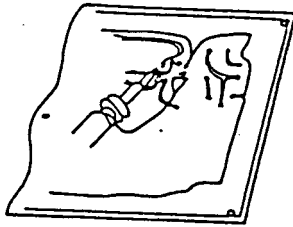

(a) Proper

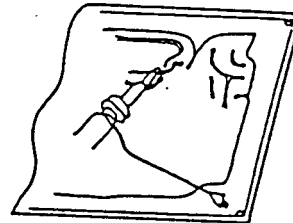

(b) Improper

Connection of ground lead

- c) To avoid effect of the ground lead in high frequency measurement, it is recommended to use the standard ground lead attachment with the AT-10AP1.5 probe.
- d) To avoid a measurement error, probe compensation must be done especially when probes are changed. Connect the probe tip to the PROBE ADJUST 0.5 V output terminal and the probe ground lead to the GND terminal. A 1 kHz square wave should be displayed with flat tops. Any distortion in the presentation is caused by incorrect probe compensation. If overshoot or undershoot is present, turn the screwdriver adjustment in the probe for a flat-top presentation.

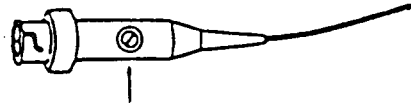

Screwdriver adjustment



(a) Optimum



(b) Capacity too small



(c) Capacity too large

(2) Direct connections

When connecting signals without using the supplied probe, pay attention to the following points in order to minimize a measurement error.

- o When using an unshielded lead, there should be no trouble, provided the circuit under measurement is of low impedance source and high level. However, in most cases, measurement errors may be caused by stray coupling with other circuits or power line interference. This can cause errors even at low frequencies.
In general, avoid measuring with an unshielded lead.
- o When using a shielded wire, it is desirable to use a coaxial cable with a BNC type connector. If a BNC type connector is not available, connect one end of the shield to the ground terminal of the instrument and the other end to the ground of the circuit to be measured.
- o The following precautions must be observed when performing a wide bandwidth measurement. It is necessary to terminate the cable with a characteristic impedance when measuring a fast rise waveform or a high frequency wave.

The absence of a termination resistor will result in a measurement error due to a ringing phenomenon when a long cable is used. Some measuring circuits require a termination resistor equal to the characteristic impedance of the cable. (A BNC type termination resistor is recommended for this purpose).

- o In order to perform measurements with the circuit in a proper operating state, it is sometimes necessary to terminate the cable with an impedance which corresponds to the circuit being measured.
- o The stray capacity of the shield wire must be taken into account when performing measurements with a long shield wire. Since a shield wire has a capacity of about 100 pF per meter, its effect on the test circuit cannot be ignored.

Use a X10 probe to minimize the effect on the circuit.

- o When a shield wire or a non-terminated cable is used, and the cable length reaches $1/4$ the wave length or its multiples ($1/4$ the wave length is about 0.5 meter when using a coaxial cable at 100 MHz), oscillation may be caused in the 2 to 5 mV/DIV ranges.

This is caused by the resonance between the externally connected high-Q inductance and the input capacity. Reduce the Q by connecting the cable or shield wire to the input connector by the resistors from 100 Ω to 1 k Ω connected in series, or by performing measurements at another VOLTS/DIV range.

8. BASIC OPERATIONS AND MEASUREMENT PROCEDURES

The measurement is provided with the NON STORE mode function and the STORAGE mode function, and the selection of the modes can be made by the switches of the STORAGE MODE section. The basic operations are described below.

NOTE:

Prior to measurements, allow 20 minutes of warmup time.

8.1 Data Display

(1) NON STORE mode display

Data display positions on the CRT

Delay time, holdoff, cursor measurement displays

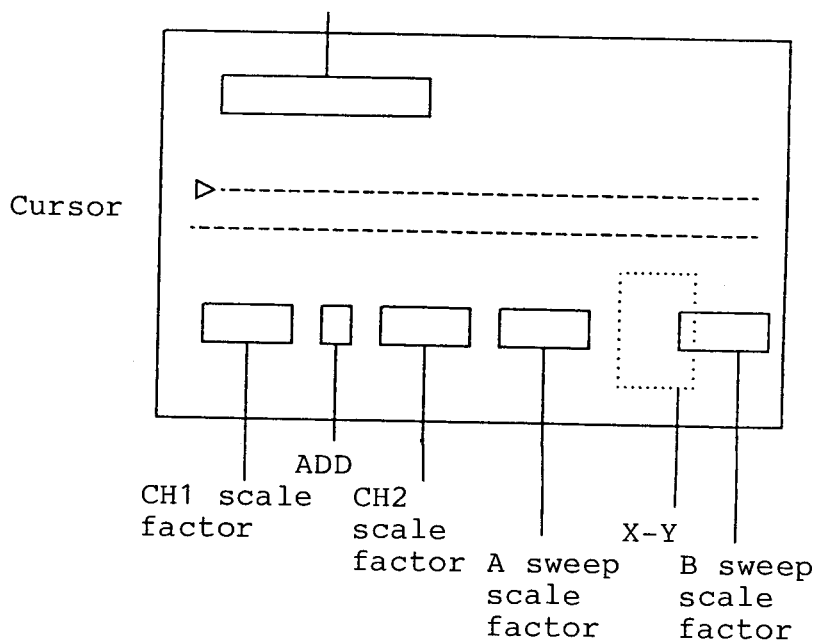

1 CH1 and CH2 scale factor displays

```
P1 OX > 1 0 m V
```

Probe display

Blank : CAL

P_{10X} : 10X probe

> : UNCAL

Blank: 1X probe

In the ADD mode, "+" is displayed between scale factors of CH1 and CH2.

② A sweep, B sweep, and X-Y scale factor displays

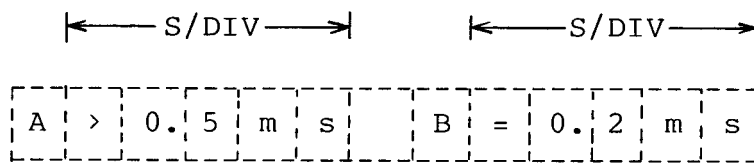

=: X1 CAL
 *: X10 MAG
 >: UNCAL

In the X-Y operation mode,
 X-Y is displayed and the
 TIME/DIV setting data dis-
 appears.

③ Delay time display

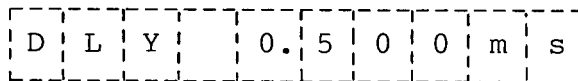
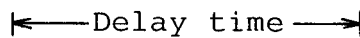

ms : A TIME/DIV (CAL)
 div: A TIME/DIV (UNCAL)

Shows that the HORIZONTAL MODE switch is set to
 ALT or B.

④ HOLDOFF and TRIGGER LOCK displays

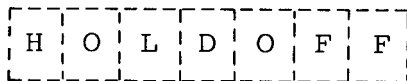

MIN: Minimum
 ▷▷▷: Holdoff time is graphed.
 MAX: Maximum

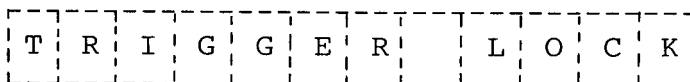

Displayed in the TRIGGER LOCK mode.

5 Cursor measurement value display

A measurement value between cursors is displayed.

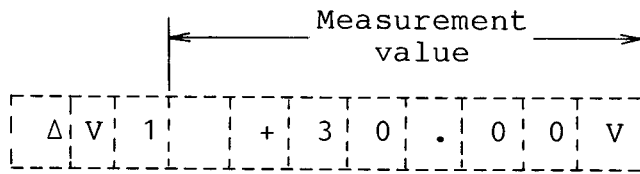

$\Delta V1$: CH1

$\Delta V2$: CH2

ΔV^1_2 : ADD

ΔTA : Time difference between
two cursors for A TIME/
DIV

$1/\Delta TA$: Reciprocal number of
 ΔTA

ΔTB : Time difference between
two cursors for B TIME/
DIV

$1/\Delta TB$: Reciprocal number of
 ΔTB

ΔV : +, -, mV, V, div

ΔT : +, -, ns, μs , ms, s, div

$1/\Delta T$: mHz, Hz, kHz, MHz, ?

"div" is displayed in the
following cases:

- o The measurement value in
the channel selected by the
VERTICAL MODE switch is not
in the CAL state.

- o The VERTICAL MODE is set to
ADD, and the VOLTS/DIV set-
tings of CH1 and CH2 are
not equal.

- o The HORIZONTAL MODE switch
is A, and the TIME switch
and the VARIABLES control
function.

(UNCAL state, CRT display:>)

(2) STORAGE mode display

Data display positions on the CRT

PRETRIGGER, NO. OF SWEEPS, MAG POINT, STOR VPOS,
delay time, holdoff, and cursor measurement data,
and automatic measurement data

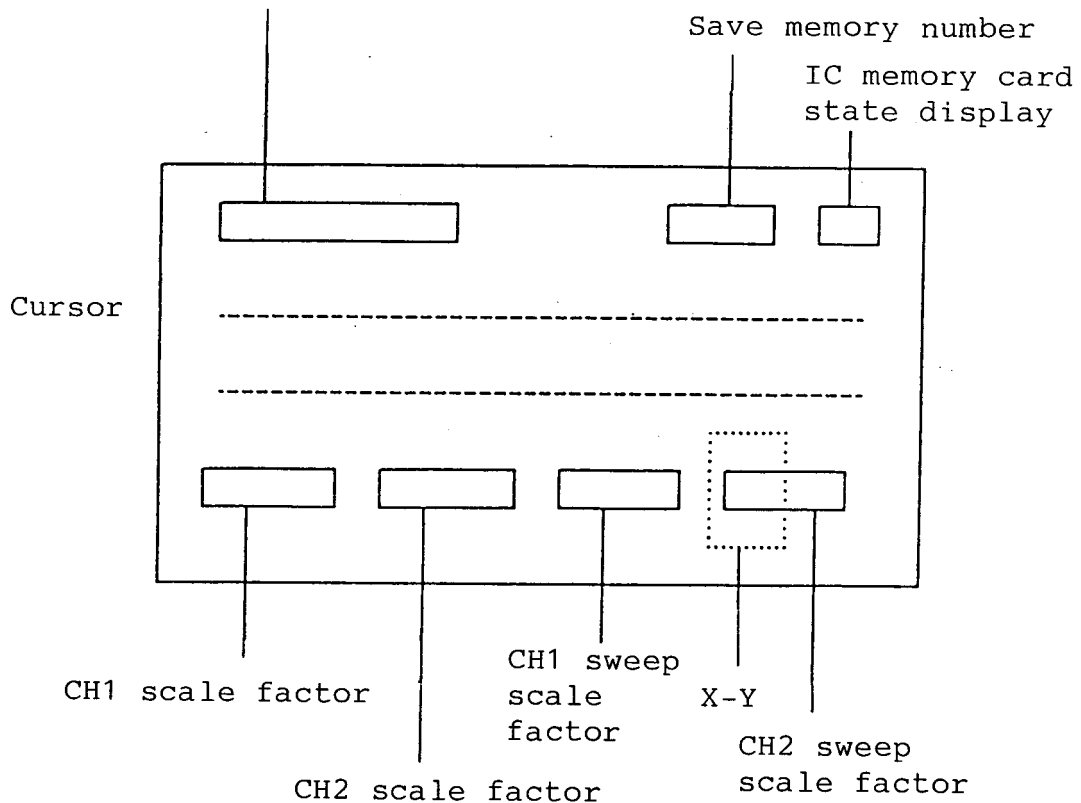

NOTE:

In the STORAGE MODE, the waveform can be displayed while the input signal is stored. Moreover, the waveform previously stored can be displayed. The scale factors and the panel setting conditions of the waveforms displayed at CH1 and CH2 may be different.

The instrument stores the scale factor and the setting conditions related to the waveforms as far as the waveform is stored. When the waveform is displayed, these values can be displayed at any time.

- o Scale factor and sweep scale factor

When the waveform of CH1 or CH2 is displayed, the scale factors corresponding to the waveform are displayed as shown in page 46.

- o PRETRIGGER, NO. OF SWEEPS, delay time, cursor measurement, and automatic measurement

The value of the sweep waveform corresponding to the selection of the **■** CH1 **■** CH2 switch in the STORAGE MODE section is displayed. When the sweep waveform selected by this switch is not displayed, the value is not displayed, either.

The FREQ measurement is performed for the signal selected by the TRIGGER SOURCE or X switch.

① CH1 and CH2 scale factor displays

(Example) P₁ 10X > 1 0 m V

Probe display

P₁10X : 10X probe

Blank: 1X probe

Blank : CAL

> : UNCAL

In case of the stored waveform in the ADD mode:

When the scale factors of CH1 and CH2 are equal, the scale factors are displayed at the CH1 factor position.

When the scale factors of CH1 and CH2 are different, ADD is displayed at the CH1 factor position.

② CH1 and CH2 sweep scale factor displays and X-Y display

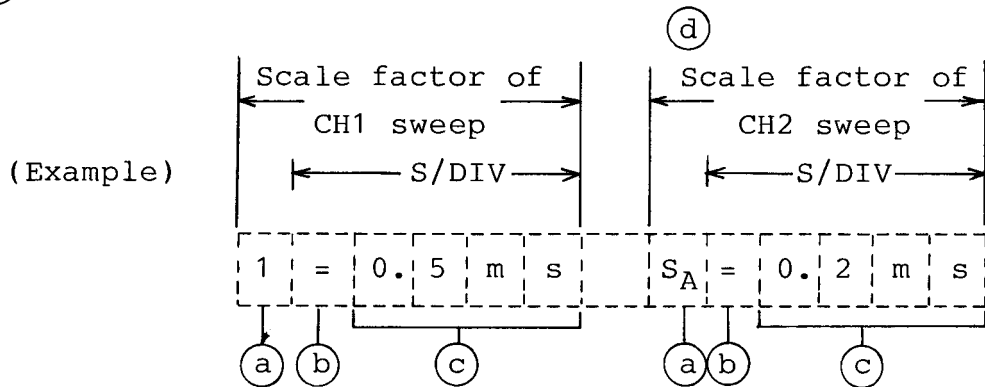

① Memory No. of the display waveform

1: CH1 display memory

2: CH2 display memory

S_X (X = A, B, 1 to 15)

NOTE:

The suffix X indicates the save memory A or B in the instrument or the number of the save memories 1 to 15 in the IC memory card. Hereafter, "S_X" indicates the Xth save memory.

② =: X1 or CAL

*: Magnification without interpolation (X2 to X100)

: Magnification with linear interpolation (X2 to X100)

: Magnification with sine interpolation (X2 to X100)

>: UNCAL

③ EXT is displayed in the EXT CLK mode.

S/DIV is displayed in other modes.

(Example: S1 = EXT)

④ In the X-Y operation, the scale factor of CH2 disappears, and the X-Y is displayed. This means that the waveform stored with the scale factors of CH1 is displayed in the X-Y mode.

③ STORAGE data

- o The display of the PRETRIGGER: (*1)

The triggering point of the waveform.

(Example:

T	R		9	.	9	d	i	v
---	---	--	---	---	---	---	---	---

)

- o The display of the NO. OF SWEEPS: (*1)

The number of sweeps processed in the average mode.

(Example:

A	V			2	5	6		
---	---	--	--	---	---	---	--	--

)

- o The display of the MAG POINT:

The start point of horizontal magnification.

(Example:

M	A	G		9	.	0	d	i	v
---	---	---	--	---	---	---	---	---	---

)

- o The display of the STOR V POS:

The movable storage waveform.

(Example:

V		P	O	S		(C	H	-1)
---	--	---	---	---	--	---	---	---	----	---

)

(*1) When the SAVE memory waveform is displayed, the setting data of PRETRIGGER or No. OF SWEEPS at the time when the SAVE memory waveform was stored is displayed. When the SAVE memory is displayed, the display like "TRS 9.9 div" or "AVS 256" is made.

Example: When X = A, TRS_A 9.9 div is displayed.

When X = 12, AVS₁₂ 256 is displayed.

④ Delay time display

←Delay time→

(Example)

D	L	Y		0	.	5	0	0	m	s
---	---	---	--	---	---	---	---	---	---	---

|
Shows that the HORIZONTAL MODE switch is set to B.

⑤ **HOLDOFF and TRIGGER LOCK displays**

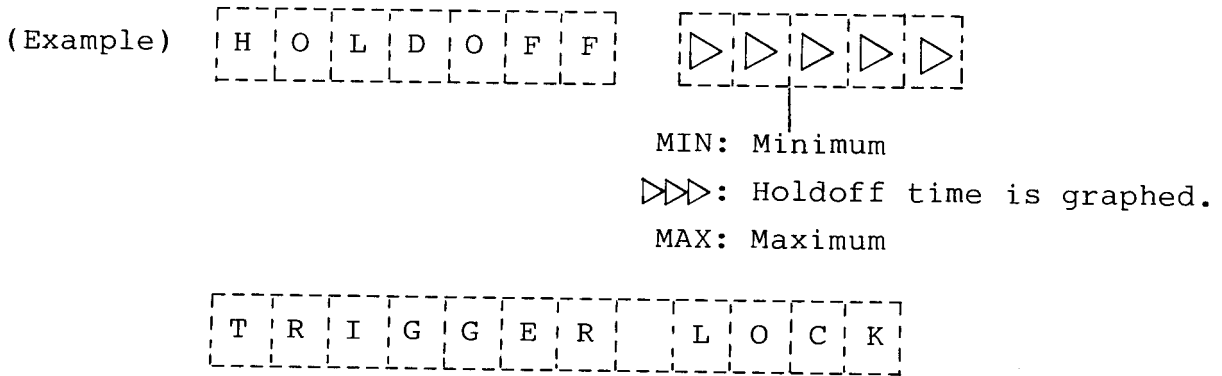

Displayed in the TRIGGER LOCK mode.

(*1) When the save memory waveform is displayed, the PRETRIGGER and NO. OF SWEEPS settings at the point where the waveform is stored are displayed. When S_X is displayed, "TRS_X 9.9 div" and "AVS_X 256" are displayed.

Example: When X = A, TRS_A 9.9 div is displayed.
 When X = 12, TRS₁₂ 256 is displayed.

⑥ **Cursor measurement value display**

A measurement value between cursors is displayed.

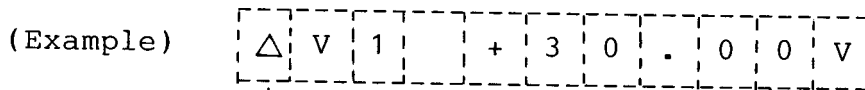
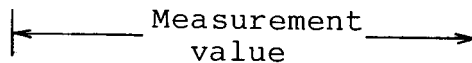

ΔV1: Voltage difference between two cursors for the CH1 sweep waveform
 ΔV2: Voltage difference between two cursors for the CH2 sweep waveform
 ΔSX: Voltage difference between two cursors for the save memory S_X waveform

ΔV: +, -, mV, V, div
 ΔT: +, -, ns, μs, ms, s
 1/ΔT: mHz, Hz, kHz, MHz, ?
 H: .PT
 "div" is displayed in the following cases:
 o The measurement value in the channel selected by the VERTICAL MODE switch is not in the CAL state.

- $\Delta T1$: Time difference between two cursors for the CH1 sweep waveform
 - $1/\Delta T1$: Reciprocal number of $\Delta T1$
 - $\Delta T2$: Time difference between two cursors for the CH2 sweep waveform
 - $1/\Delta T2$: Reciprocal number of $\Delta T2$
 - $\Delta H1$: Number of sampling points of the CH1 sweep waveform
 - $\Delta H2$: Number of sampling points of the CH2 sweep waveform
 - ΔTS : Time difference between two cursors for the save memory S_X waveform
 - $1/\Delta TS_A$: Reciprocal number of ΔTS
 - ΔHS_X : Number of sampling points of the save memory S_X waveform
- o The VERTICAL MODE is set to ADD, and the VOLTS/DIV setting of CH1 and CH2 are not equal.

⑦ Automatic measurement display

a Automatic Vpp measurement display

The absolute value of the difference between the maximum and minimum voltages of the waveform being displayed on the screen is displayed.

(Example)

P	P	1		+	3	0	.	0	0	V
---	---	---	--	---	---	---	---	---	---	---

PP1: Voltage difference of the CH1 sweep waveform

PP2: Voltage difference of the CH2 sweep waveform

b Automatic FREQ measurement display

The frequency of the signal selected by the TRIGGER SOURCE OR X switch is displayed.

(Example)

F	R	E	Q		9	9	9	.	9	kHz
---	---	---	---	--	---	---	---	---	---	-----

⑧ SAVE memory display

The selected SAVE memory number is displayed.

(Example)

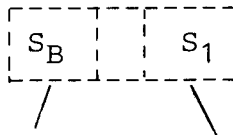

Number of the SAVE memory waveform displayed instead of the CH1 waveform

Number of the SAVE memory waveform displayed instead of the CH2 waveform

9 IC memory card state display

When the voltage of the battery becomes short, "B" is displayed.

NOTES:

- a) Readout display appears when the power is turned on. If this display is not needed, select H POS by the SELECTOR switch, and rotate the VARIABLES control ⑩ counterclockwise while holding the SELECTOR switch upward. The readout display then disappears. To obtain the readout display again, select H POS, and rotate the VARIABLES control ⑩ clockwise, while holding the SELECTOR switch upward.
- b) The P_{10X} display is initialized when the power is turned on. To blank the display, select H POS by the SELECTOR switch, and rotate the VARIABLES control counterclockwise while holding the SELECTOR switch downward. To obtain the display again, select H POS, and rotate the VARIABLES control clockwise, while holding the SELECTOR switch downward. The probe display can be switched to 1X or 10X only for the channel selected by the VERTICAL MODE switch.

8.2 NON STORE Mode

The instrument works as a conventional oscilloscope.

(1) Normal sweep display

- ① Set the switches, and controls as shown in Table 8-1. Check that the NON STORE switch of the STORAGE MODE is set to ON.

Table 8-1 Initial setting of basic display

Vertical axis	VOLTS/DIV VAR AC-DC GND POSITION VERTICAL MODE	Set according to the amplitude of the applied signal. CAL (Fully clockwise) AC Off (Pulled out) Mid-position CH1
CRT	INTEN FOCUS	Proper position Mid-position
Horizontal axis	HORIZONTAL MODE X10 MAG	A Off (Pulled out)
Trigger	TRIGGER LEVEL TRIGGER MODE SOURCE OR X	Mid-position AUTO CH1

- ② Connect the signal to CH1 INPUT connector using a probe or a coaxial cable which meets the input impedance. Refer to Section 7 for connection.
- ③ Adjust the INTEN control for proper illumination.
- ④ Adjust the VOLTS/DIV of CH1 and the vertical POSITION control so that the trace is displayed within the screen.
- ⑤ Adjust the TRIGGER LEVEL control for stable display.
- ⑥ Adjust the TIME/DIV switch so that the trace is displayed at a proper cycle. Use the FOCUS control, if necessary.

(2) In the case of measuring a single waveform

Use CH1 or CH2 when measuring a single waveform.

Make the following settings when using CH1:

VERTICAL MODE switch: CH1
 TRIGGER SOURCE OR X switch: CH1
 TRIGGER MODE switch: AUTO
 AC-DC switch: AC or DC

Under these settings, almost all the repetitive signals of approximately 30 Hz or more supplied to CH1 can be triggered and measured by adjusting the TRIG LEVEL control (within high sweep range from 2 ms/DIV of the TIME/DIV switch). Since the TRIGGER MODE of the horizontal axis is at AUTO, the trace appears even when no signal is present or when the GND switch is at GND. This means that the DC voltage can be measured.

The following switching is needed when measuring low frequency signals of approximately 30 Hz or less.

TRIGGER MODE switch: NORM

Triggering can be effected by operating the TRIG LEVEL control under this setting.

When using CH2 only, use the instrument after making the following settings.

VERTICAL MODE switch: CH2

TRIGGER SOURCE OR X switch: CH2

(3) In the case of measuring two waveforms

Measurement of two waveforms can be made easily by setting the VERTICAL MODE select switch to DUAL.

NOTES:

- a) When the A TIME/DIV setting is at 5 ms/DIV or slower in the DUAL mode, the mode is automatically set to the CHOP mode. When the TIME/DIV setting is at 2 ms/DIV or higher, the mode is automatically set to the ALTERNATE mode. If the CHOP mode is required when the TIME/DIV setting is at 2 ms/DIV or higher, press both the CH1 and DUAL switches.
- b) To measure the phase difference, trigger on the leading signal.

(4) In the case of measuring a waveform in the X-Y mode

When the HORIZONTAL MODE is set to X-Y, this instrument operates as an X-Y oscilloscope.

The X (horizontal) axis input is selected by the TRIGGER SOURCE OR X. The Y (vertical) axis input can be used in CH1, CH2, and the dual trace.

NOTES:

- a) Set the horizontal magnifying switch (X10 MAG) to off.
- b) Set the BW LIMIT 20 MHz switch to off.

8.3 Digital Storage Functions

The operating procedures of the digital storage functions are described below.

(1) Normal storage mode (NORM)

- ① Display the waveform to be stored in the NON STORE mode.
- ② Press the NORM switch.
- ③ In this mode, a waveform is swept every trigger according to the setting state of controls on the front panel, the waveform to be stored is displayed on the CRT as it is. The slower the sweep rate, the longer the time is required for the acquisition and display of the waveform. It takes approximately 12 seconds until a waveform is acquired at the sweep range of 0.5 s/div. The trigger signal is generated thereafter. Therefore, when the sweep rate is slow, the waveform is not displayed on the CRT immediately after the controls on the front panel have been adjusted.
- ④ When the TIME/DIV control is from 2 μ s/div to 0.5 s/div (17 steps), both the single and the repetitive waveforms can be stored. When the TIME/DIV control is from 50 ns/div to 1 μ s/div (5 steps), the repetitive waveform only can be stored and an asynchronous signal can not be stored correctly. This range is called the repeat mode range. Precautions for the repeat mode range are shown below.
 - a) The first (left end) rising and falling edges of the trace may not be displayed in the repeat mode range. In this case, measure the rising or falling edge on the second or later cycles of the waveform.

First (left end) rising and falling edge of the trace can not be measured.

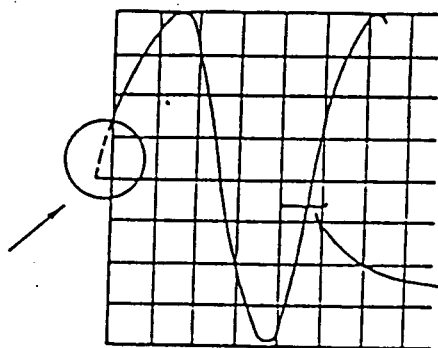

Measure the rising and falling edges of the trace on and after the second cycle of the waveform.

Example of repeat mode range display

- b) It takes 8 seconds or more to store the input signal of 1 kHz or lower.
 - c) When the low frequency signal is stored, noise can be mixed. It is recommended to use a sine wave of 1 MHz or higher or a square wave with the rise time which is faster than 0.3 μ s.
- ⑤ When the HOLD switch is pressed in the normal storage mode, the updating operation of the CRT display stops, and the CRT display at that time can be held.

(2) Average mode (AVG)

The AVG mode is used to measure the synchronous fundamental signal after eliminating noise components from the signal including asynchronous noises.

Take the following procedures.

- ① Setting of the number of sweeps to be averaged
 - a) Select NO. OF SWEEPS by the SELECTOR switch in the STORAGE MODE. Then the number of sweeps is displayed on the upper left side of the CRT.
 - b) Set to an appropriate number by the VARIABLES rotary control. Clockwise rotation increases the number and counterclockwise rotation decreases it.
- ② Press the NORM switch and allow a trace to be displayed on the CRT. Set the TRIGGER MODE rotary switch to NORM, and rotate the TRIGGER LEVEL control to stabilize the trace.
- ③ Press the AVG switch.
- ④ The waveform data acquired by the preset number of the sweeps are averaged and the display is updated repeatedly. When the HOLD switch is pressed, the waveform at that time can be held.

NOTES:

- a) The number of the sweeps of AVG is selectable from 2 to 256 (the number of two to the nth power).
- b) The digital storage circuit displays the averaged waveform after acquiring the preset number of sweeps. In the continuous operation mode, a new storage cycle starts while the previous averaged waveform is being displayed. This cycle repeats until a new mode is selected. When the data being acquired are affected by changing the setting position of controls on the front panel and the previous data is abandoned, a new waveform selected by this setting is acquired and a new storage cycle thus starts.
- c) When the NO. OF SWEEPS is set to 256, it takes approximately a minute until the signal is averaged and the resultant waveform is displayed. The SAMPLING LED blinks 256 times for approximately a minute to indicate the averaging is being performed.

(3) Envelope mode (ENV)

The envelope of the amplitude modulated waveform is displayed, and the pulse waveform having the width of 100 ns or more can be detected at a low speed time range.

- ① Press the ENV switch to start the envelope display operation mode.
- ② Select a sweep range by the TIME/DIV switch so that the input signal can be easily measured. The TIME range is selectable within the following ranges.
 - A TIME/DIV : 0.1 ms/div to 0.5 s/div
 - B TIME/DIV : 0.1 ms/div to 50 ms/div
 - A TIME/DIV \geq B TIME/DIV
- ③ Press the HOLD switch to on when measuring the fixed final CRT waveform by stopping the sampling operation in the ENV mode.

NOTES:

a) The sampling rate in the STORAGE mode

In the normal display without horizontal magnification in the STORAGE mode, the horizontal full scale of 10 div on CRT consists of 4000 sampling data. But, in the specific TIME range, the number of the sampling data consisting of the horizontal full scale changes as shown in Table 8-2. Therefore, the sampling rate in each sweep range is defined by the calculation equitation of the sampling rate as shown in Table 8-3.

Table 8-2 The numbers of the sampling data consisting of the horizontal full scale

Model	Ranges other than 2 μ s/DIV and 5 μ s/DIV	5 μ s/DIV range	2 μ s/DIV range (at one-channel sampling)	2 μ s/DIV range (at two-channel simultaneous sampling)	EXT CLK mode
VC-6275	4000 points	4000 points	4000 points	2000 points	4000 points
VC-6175	4000 points	4000 points	2000 points	2000 points	"
VC-6075	4000 points	2000 points	1000 points	1000 points	"

Table 8-3 The calculation equitations of the sampling rate

Model	Ranges other than 2 μ s/DIV and 5 μ s/DIV	5 μ s/DIV range	2 μ s/DIV range (at one-channel sampling)	2 μ s/DIV range (at two-channel simultaneous sampling)
VC-6275	$\frac{400 \text{ samples}}{\text{TIME/DIV}}$	$\frac{400 \text{ samples}}{5 \mu\text{s}} = 80 \text{ Msp}$	$\frac{400 \text{ samples}}{2 \mu\text{s}} = 200 \text{ Msp}$	$\frac{200 \text{ samples}}{2 \mu\text{s}} = 100 \text{ Msp}$
VC-6175	$\frac{400 \text{ samples}}{\text{TIME/DIV}}$	$\frac{400 \text{ samples}}{5 \mu\text{s}} = 80 \text{ Msp}$	$\frac{200 \text{ samples}}{2 \mu\text{s}} = 100 \text{ Msp}$	$\frac{200 \text{ samples}}{2 \mu\text{s}} = 100 \text{ Msp}$
VC-6075	$\frac{400 \text{ samples}}{\text{TIME/DIV}}$	$\frac{200 \text{ samples}}{5 \mu\text{s}} = 40 \text{ Msp}$	$\frac{100 \text{ samples}}{2 \mu\text{s}} = 50 \text{ Msp}$	$\frac{100 \text{ samples}}{2 \mu\text{s}} = 50 \text{ Msp}$

b) The sampling rate in the ENV mode

The number of the sampling data consisting of the CRT waveform is 4000 dots/10 div as in the other operation mode. Therefore, the sample period of the display data is $\frac{\text{TIME/DIV}}{400}$.

In order to display the envelope, the maximum and the minimum values obtained in the period of 2 times the above sampling cycle are displayed alternately. Therefore, each sampling cycle of the maximum and the minimum values is $\frac{\text{TIME/DIV}}{200}$.

200 M sampling/sec sampling (VC-6275 only)

The instrument realizes 200 Ms/sec by using two 100 Ms/sec AD converters. Therefore, the maximum sampling rate is changed as follows by the VERTICAL MODE at the 2 $\mu\text{s/div}$ TIME range.

2 $\mu\text{s/div}$ range

VERTICAL MODE	Maximum sampling rate
CH1 CH2	200 Msps
ALT CHOP ADD	100 Msps

(4) ROLL mode

The displayed waveform is rolled from right to left. The right end of each trace is the updating point of a new data.

The ROLL mode facilitates measurement of a signal of approximately 100 Hz or lower.

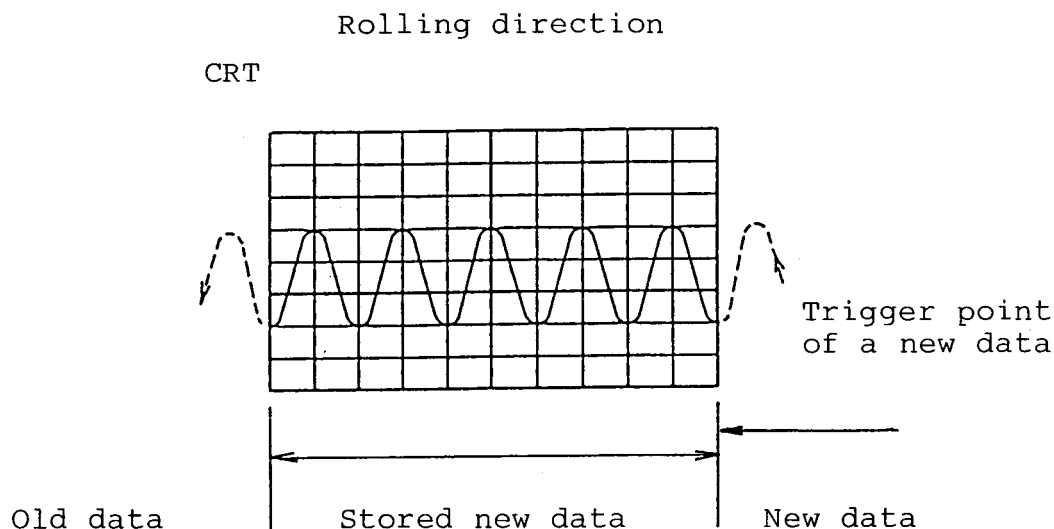

Fig. 8.1

- ① Press the AVG and ENV switches simultaneously. Then, the ROLL mode display starts.
- ② Select a TIME range by the TIME/DIV switch so that the input signal can be easily measured.
* Selectable time range in the ROLL mode: 0.1 s/div to 50 s/div
- ③ Press the HOLD switch to stop the ROLL mode and hold the final waveform on the CRT.

NOTE:

In the ROLL mode, the functions other than H POS, MEASURE, STOR V POS are not selected by the SELECTOR switch.

(5) External sampling clock mode (EXT CLK)

In this mode, the signal of CH1 or CH2 is sampled by the clock supplied from the EXT CLK terminal on the rear panel.

- ① Setting of the external sampling clock operation
 - a) Connect an external sampling clock (reference clock for sampling) to the EXT CLOCK INPUT connector on the rear panel.
 - b) Press the NORM switch.
 - c) Press the right side (>) of the TIME/DIV switch to set 50 ns/div. Further, press this switch twice to establish the operation mode by the external sampling clock. At this time, "EXT" is displayed on the sweep scale factor of the CRT.

The time required for the acquisition and display of the waveform is in proportion to the duration of the signal supplied as an external sampling lock.

NOTE:

Supply a TTL output signal as an input signal of the external sampling clock.

When the signal with slow rise and fall time (more than approximately 20 ns) is supplied, the sampling may not be executed normally. In this case, set the HOLD mode once, and then set to the EXT CLK mode. Therefore, it is required to supply the external sampling clock with fast rise and fall time (less than 20 ns).

- ② Release from the external sampling clock operation

The EXT CLK mode is released by the following operation.

 - o Press the left side (<) or the center (AUTO) of the TIME/DIV switch .
 - o Press ALT or B of the HORIZONTAL MODE switch.
 - o Press the NON STORE, ENV, or ROLL switch.

- ③ Cursor and automatic measurements by the external sampling
- a) ΔV : The voltage difference between two cursors is measured.
 - b) ΔH : The number of the sampling points between two cursors is measured.
 - c) V_{pp} : The difference between the maximum and minimum values of the waveform is measured.
- (For the cursor and automatic measurements, refer to item 8.4 General Measurement.)

NOTES:

- a) In the following cases, the external sampling is not executed.
 - o When the TIME/DIV switch is set to the time axis, the TRIGGER LOCK switch is pressed.
 - o The NON STORE, ENV, or ROLL switch is pressed.
 - o ALT or B of the HORIZONTAL MODE switch is pressed.
 - o When the TIME/DIV switch is set to the time axis, the HOLD switch is pressed.
- b) In the external sampling mode, the following functions do not operate.
 - o TRIGGER LOCK function
 - o Frequency measurement (automatic)
 - o Cursor measurement of ΔT and $1/\Delta T$
 - o Horizontal magnification display by the TIME/DIV switch
- c) Since the external sampling mode and the sampling mode of the time axis are performed independently, the measurements relating to the time of the data sampled in the EXT CLK mode are not performed.
- d) The pretrigger amount is set from 0 to 9.9 div in 0.1 div steps.
- e) The MAG POINT amount is set from 0 to 9.0 div in 0.1 div steps.

④ Discrimination of aliasing

When measuring the signal in such STORAGE mode as NORM, AVG, etc., aliasing can occur when an input signal which has more than half of the frequency with respect to the sample clock frequency at the sweeping range is added.

When aliasing occurs, the waveform of the input signal frequency minus the sample clock frequency will be displayed. It is possible that this display is judged a correct waveform. If aliasing is doubted, set the instrument to the NON STORE mode or the ENV mode, and check if the measuring waveform is the same with the waveform in the measuring mode. When aliasing occurs, the waveform equal to the input signal frequency minus the sample clock frequency is displayed in the NORM mode, and the waveform with flat top and bottom is displayed in the ENV mode or the NON STORAGE mode. If there is a difference in these two waveforms, aliasing occurs.

(6) HOLD mode

When the HOLD switch is pressed in the NORM, the AVG, the ENV, or the ROLL mode, the HOLD mode is set. In this mode, the sampling operation in each operation mode is interrupted, the waveform display data at the time when the mode was changed to the HOLD mode is continued to display.

NOTES:

- a) When the mode is changed from NON STORE to HOLD, the waveform displayed in the STORAGE MODE is displayed again just before the mode was changed to the NON STORE mode.
- b) When the power is set to on with the HOLD switch pressed, a horizontal trace is displayed at the center of the CRT.

The four functions, the PLOT, SINGLE, SAVE and SAVE# shown shown in the right figure, are available only in the HOLD mode.

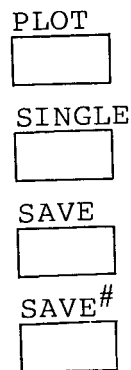

(7) SAVE in the HOLD mode

The waveform data of CH1, CH2, and ADD which are sampled and displayed in the STORAGE MODE can be stored in the save memory. The data stored in the save memory can be displayed on the CRT by the DISP SAVE operation.

SAVE operation

- a) The sampling data of CH1 is displayed in the STORAGE MODE. When the HOLD switch is pressed, the waveform is held.
- b) Select the save memory number to be stored by the SAVE# switch.

Each pressing this switch increments the number one by one when CH1, CH2, or ADD of the VERTICAL MODE switch is pressed, and two by two when CHOP or DUAL is pressed.

- o When CH1, CH2, or ADD of the VERTICAL MODE switch is pressed,

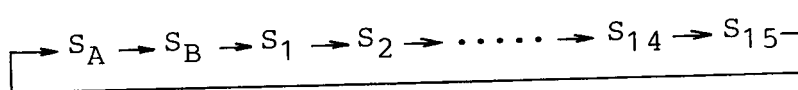

When the IC memory card is inserted

or

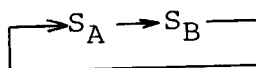

When the IC memory card is not inserted.

o When CHOP or DUAL of the VERTICAL MODE switch is pressed,

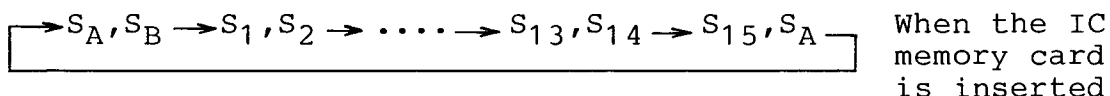

or

S_A, S_B

When the IC memory card is not inserted.

NOTE:

When the VERTICAL MODE is changed to DUAL or CHOP with the save memory number displayed in CH1, CH2, or ADD mode, the displayed save memory number and its next number are displayed. Hereafter, the number increases two by two.

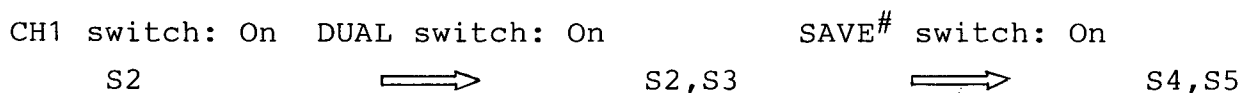

c) When the SAVE switch is pressed after the save memory number is selected, the waveform data is stored in the save memory.

While the data is being transferred to the save memory, the LED above the PLOT switch lights in green.

d) When the waveform data has been stored in the selected save memory, the LED goes off.

The saved waveform data continues to be saved unless a new waveform data is stored by the above operation.

NOTES:

a) The save memory numbers S_A and S_B are the save memories in the instrument.

The save memory numbers S_1 to S_{15} are the save memories in the IC memory card.

b) When the save memories S_A and S_B are averaged or interpolated, the stored waveform data is destroyed.

c) The waveform data of CH1, CH2, or ADD can be stored in the save memory. The relationship between the VERTICAL MODE switch and the stored waveform data is illustrated in next page.

Save memory No. VERTICAL MODE	Save memory X	Save memory X+1
CH1	Waveform displayed on CH1	
CH2	Waveform displayed on CH2	
DUAL or CHOP	Waveform displayed on CH1	Waveform displayed on CH2
ADD	Waveform displayed on CH1	

- i) $X = A, B, \text{ and } 1 \text{ to } 15$ $X = 15, X + 1 = A$
- ii) The waveform displayed on CH1 means the waveform which can be moved vertically by the VARIABLES control when CH1 is selected by the STOR V POS switch.
- iii) The waveform displayed on CH2 means the waveform which can be moved vertically by the VARIABLES control when CH2 is selected by the STOR V POS switch.

(8) Display of the save memory

The contents of the save memory stored by the save operation in the HOLD mode are displayed on the CRT by the following operation, and can be compared with a current waveform. But the save memory can not be displayed in the operation of the NON STORE, the ROLL, or the AVG mode.

- ① Press the DISP SAVE switch.
- ② Select the save memory number to be displayed by the SAVE# switch.

The waveform data stored in the save memory is displayed in accordance with the VERTICAL MODE switch selection.

- ③ When the waveform of the save memory is superimposed on the displayed waveform, move the waveform of the save memory by the STOR V POS for easy measurement.
- ④ When the waveform of the save memory is not necessary, turn the DISP SAVE switch to off. Then, the waveform disappears.

NOTES:

a) The relationship between the VERTICAL MODE switch and the stored waveform data is as follows.

Save memory	Waveform displayed on CH1	Waveform displayed on CH2
VERTICAL MODE		
CH1	Input waveform to CH1	Save memory X
CH2	Save memory number X	Input waveform to CH2
DUAL or CHOP	Same memory number X	Save memory number X+1
ADD	Sum of the input waveforms to CH1 and CH2	Save memory number X

i) $X = A, B, \text{ and } 1 \text{ to } 15$ $X = 15, X + 1 = A$

ii) The waveform displayed on CH1 means the waveform which can be moved vertically by the VARIABLES control when CH1 is selected by the STOR V POS switch.

iii) The waveform displayed on CH2 means the waveform which can be moved vertically by the VARIABLES control when CH2 is selected by the STOR V POS switch.

b) Turn off the DISP SAVE switch with the HOLD switch pressed. Further when the VERTICAL MODE switch is set to DUAL or CHOP, the save waveform remains displayed on the CRT.

(9) Single operation in the HOLD mode

When the SINGLE switch is pressed in the HOLD mode with the STORAGE MODE set to NORM, AVG, or ENV, the sampling of each operation mode is processed and a waveform is updated once.

① Single operation procedure

a) Set the STORAGE MODE to NORM, AVG, or ENV, and adjust the controls so that the input signal is stored and displayed in the operation mode.

- b) Set the TRIGGER MODE switch to NORM, and set the TRIGGER LEVEL at the proper position to measure the input signal.
- c) Press the HOLD switch.
- d) Press the SINGLE switch.

At this time, the LED (green) above the PLOT switch lights, and the following operation is performed.

i) NORM mode

When a trigger signal is fed, a waveform data corresponding to one screen is normally sampled, and the waveform on the CRT is updated after all data is sampled. This mode is effective for storing a transient waveform.

ii) AVG mode

A trigger signal in excess of the number of the designated sweep must be fed. A sampling of 4000 data (corresponding to one sweep) is performed whenever a trigger signal is fed, and the data is accumulated. When the number of the designated sweep (2^n) finishes, the accumulated waveform data is averaged, and the result is displayed on the CRT.

iii) ENV mode

When a trigger signal is fed, the ENV mode sampling of the waveform data corresponding to one screen is performed. When the sweep completes, the envelope waveform is updated on the CRT.

- o When the above operation mode is processed once, the SINGLE operation finishes, and the LED above the PLOT switch goes off. The waveform on the CRT is held.

- ② When the SINGLE switch is pressed in the above operation, the instrument is placed in the wait state of a trigger signal. The SINGLE sampling processing is not performed until the trigger signal is applied. While the trigger of the input signal is not detected, the LED above the PLOT switch continues to light. When a signal for trigger is applied, or when the trigger mode is set to AUTO, the SINGLE processing is performed. Then the LED goes off, and this state is released.
- ③ In case that the TRIGGER MODE switch is set to AUTO, this instrument generates an AUTO TRIG signal periodically to perform the SINGLE processing if this instrument is not triggered by the input signal. Therefore, a DC signal can also be measured in this mode.

(10) The PLOT output in the HOLD mode

When an analog signal of the waveform displayed in the HOLD mode is fed out to a pen recorder or an XY recorder, or when a CRT display is written on a digital plotter via the GPIB, the command is delivered by the PLOT switch.

This section describes only the analog output to a pen recorder, an XY recorder, etc. For the output to the digital plotter, refer to section 9.

① PLOT mode

The speed of the plot, the Y-T output, and the X-Y output are selected by the DATA OUTPUT CONT switches on the rear panel. When the D.PLOT switch is on, the instrument is set to the output mode to a digital plotter, and the analog output is not obtained. Be sure to make the D.PLOT switch off (pulled out) to obtain the analog output. Select the Y-T mode to connect the waveform signal to the pen recorder, and select the XY mode to connect the signal to the XY recorder.

Rear panel						
	Plot speed	Setting switch				Remarks
		MODE		SPEED		
		D.PLOT	Y-T X-Y	SW2	SW1	
Y-T output (To a pen recorder)	1 s/div	OFF	OFF	OFF	OFF	CH1 and CH2 outputs are fed out simultaneously.
	2 s/div	OFF	OFF	OFF	ON	CH1 data: CH1 terminal
	5 s/div	OFF	OFF	ON	OFF	CH2 data: CH2 terminal
	10 s/div	OFF	OFF	ON	ON	See Fig.8-2 for connections.
X-Y output (To a XY recorder)	1 s/div	OFF	ON	OFF	OFF	CH1 or CH2 data: Y terminal
	2 s/div	OFF	ON	OFF	ON	X-axis sweep signal: X terminal
	5 s/div	OFF	ON	ON	OFF	
	10 s/div	OFF	ON	ON	ON	See Fig. 8-4 for connections.

MODE SIZE/SPEED

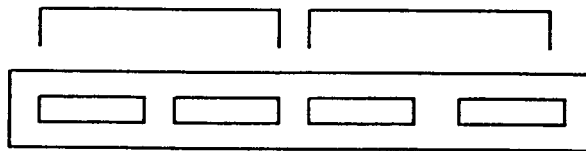

D.PLOT X-Y SW2 SW1
 A.PLOT Y-T

DATA OUTPUT CONT

② Operation (The mode needed for item 1 must be set.)

- a) Press the HOLD switch to hold the displayed waveform.
- b) Press the PLOT switch. The PLOT LED lights in green and this instrument starts to feed out the data output. After the data output is completed, the PLOT LED goes off and the PLOT mode is released.

To make the data output stop, press the PLOT switch again. Then, the PLOT mode is released and the PLOT LED goes off.

NOTES:

- a) The stored waveform display disappears from the CRT while the signal is fed to the plotter. When the output completes, the display appears again.
- b) When the HOLD switch is set to off, or to the NON STORE mode while the signal is fed to the plotter, the output is interrupted. Therefore, don't operate the operation mode switch while the output is being fed out.

③ Output to a pen recorder (Y-T output)

i) Connections

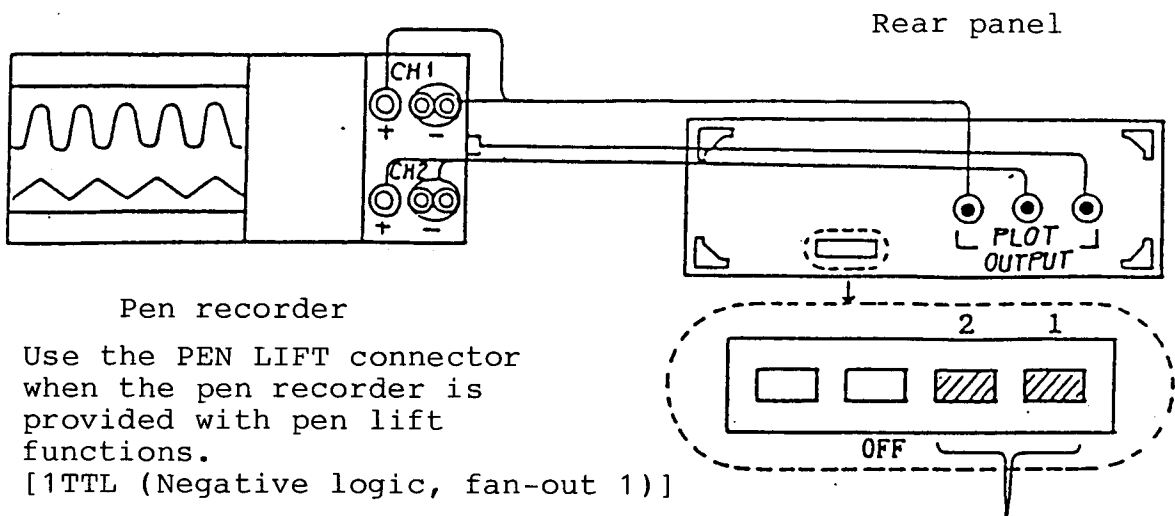

Fig. 8-2

ii) Output condition

The output timing below is common to CH1 and CH2.

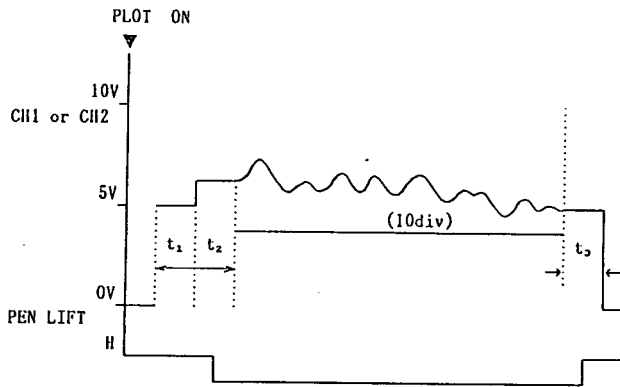

Fig. 8-3

a) Voltages corresponds to vertical axis on the CRT as follows.

10 V --- +5 div

5 V --- center

0 V --- -5 div

b) $t_1, t_2, t_3 = 2$ seconds

When the PLOT switch is pressed while data is being fed out, CH1 or CH2 is 0 V and PEN LIFT is H.

④ Output to an XY recorder

i) Connection

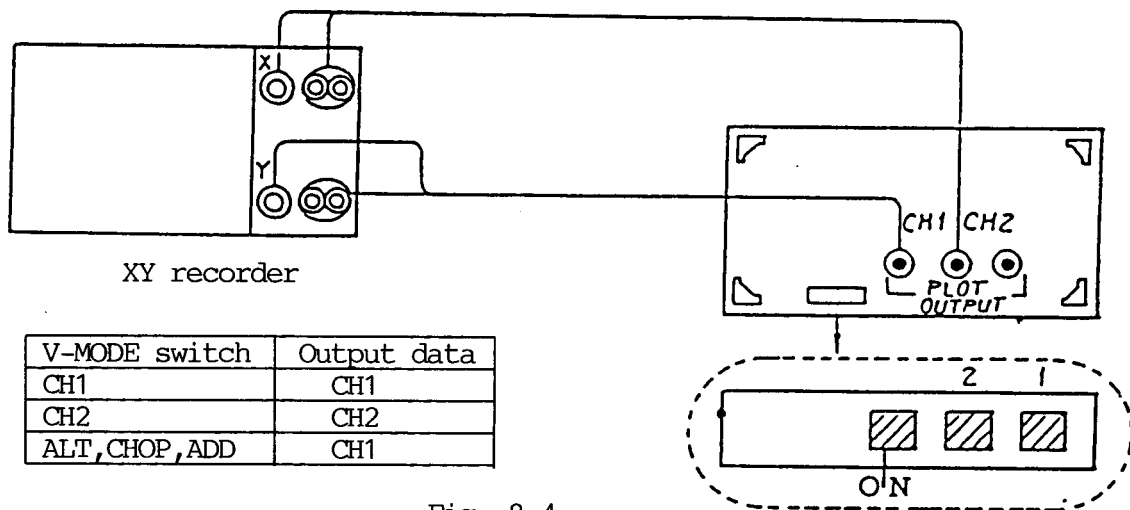

Fig. 8-4

ii) Output condition

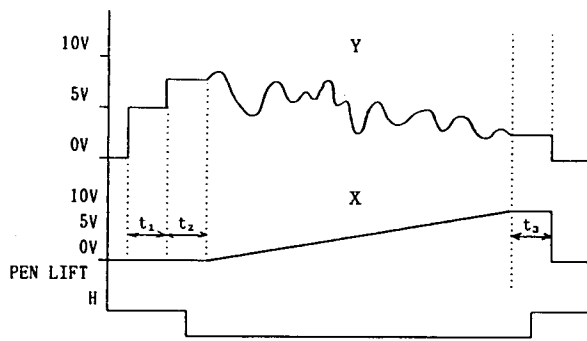

Fig. 8-5

a) Voltages corresponds to horizontal axis on the CRT as follows.

10 V --- +5 div

5 V --- center

0 V --- -5 div

b) $t_1, t_2, t_3 = 2$ seconds

When the PLOT switch is pressed again while data is being fed out, X and Y axes are 0 V and PEN LIFT is H.

(11) Horizontal magnifying display

The following three methods are valid for the horizontal magnifying display in the STORAGE operation.

1. 10 times magnification by the X10 MAG switch
2. Magnification of a HOLD waveform by the TIME/DIV switch
3. ALT MAG

① **X10 MAG**

A storage waveform displayed on the CRT is magnified by 10 times from the position pointed by the MAG POINT cursor.

a) Let the MAG POINT LED light by the SELECTOR switch.

At this time, a cursor pointing a starting point of a magnifying range is displayed. Move the cursor to the point to be magnified. Use the VARIABLES rotary control to move the cursor. The clockwise rotation moves the cursor to the right, and the counterclockwise rotation moves it to the left.

b) When the X10 MAG switch is pressed, the data at 1 div from the above trace position is magnified by 10 times.

NOTE:

When the initial waveforms of CH1 and CH2 are both displayed, both the waveforms are magnified from a cursor position.

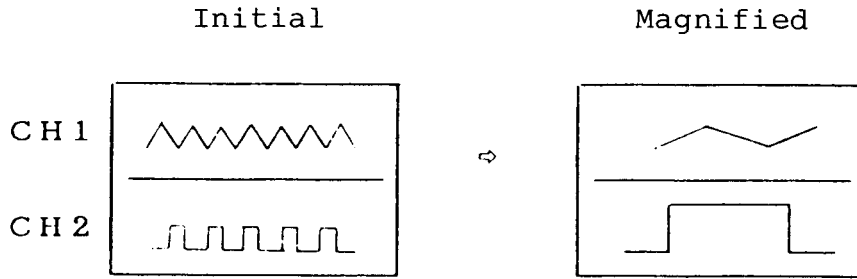

Fig. 8-6

- c) Press the X10 MAG switch again. The initial waveform will be displayed.

NOTE:

When the waveforms sampled at different sweep ranges are displayed on CH1 and CH2, the horizontal magnification by the above operation can not be performed.

② **Magnification of a HOLD waveform by the TIME/DIV switch**

When the TIME/DIV switch is operated with a storage waveform displayed in the HOLD mode, the display is magnified up to 100 times according to the setting of the TIME/DIV switch. The HOLD waveform is magnified from the MAG POINT of the initial waveform.

[Example of the magnified display]

- a) Display an initial waveform, and set the instrument in the HOLD mode.
- b) Move the position of the MAG POINT to the position to be magnified as described in 1 - a).

c) Press the right side of the TIME/DIV switch, and set the TIME/DIV to the faster setting value. The waveform is magnified according to the TIME/DIV setting value displayed on the CRT changes.

i) An initial waveform display
 TIME/DIV = 1 ms/div
 HOLD mode

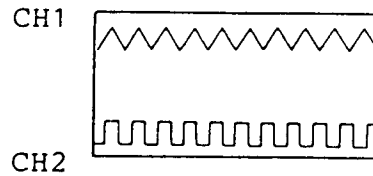

ii) When the TIME/DIV switch is pressed, the TIME/DIV display changes to 0.5 ms/div. The waveform is magnified by two times.

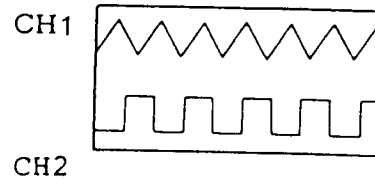

iii) When the TIME/DIV switch is pressed two times more, the TIME/DIV display changes to 0.1 ms/div. The waveform is magnified by 10 times.

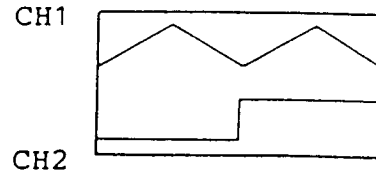

d) The maximum magnifying rate is 100 times. Therefore, the TIME/DIV setting is available down to one hundredth the initial waveform by the TIME/DIV switch. If the switch is pressed further, the TIME/DIV display does not change, or the waveform is not magnified any more.

e) When the left side of the TIME/DIV switch is pressed with the TIME/DIV set to the slower value, the magnifying rate is becoming small, and the initial waveform can be displayed at last.

NOTE:

When the waveforms sampled at different sweep ranges are displayed on CH1 and CH2, the horizontal magnification by the above operation can not be performed.

③ ALT MAG

An initial waveform and a waveform magnified are displayed simultaneously. When a waveform of CH1 is displayed in the vertical mode (CH1, DUAL, CHOP, or ADD) and the ALT MAG switch is pressed, the initial and its magnified waveforms of CH1 are displayed.

To perform the ALT MAG display of a waveform of CH2, set the VERTICAL MODE to CH2 first, and then set the instrument in the ALT MAG mode.

VERTICAL MODE	Normal display		ALT MAG	
	CH1 sweep	CH2 sweep	CH1 sweep	CH2 sweep
CH1	CH1 waveform	----	Initial waveform of CH1	Magnified waveform of CH1
CH2	----	CH2 waveform	Magnified waveform of CH2	Initial waveform of CH2
DUAL	CH1 waveform	CH2 waveform	Initial waveform of CH1	Magnified waveform of CH1
CHOP	CH1 waveform	CH2 waveform	Initial waveform of CH1	Magnified waveform of CH1
ADD	ADD waveform (CH1)	----	Initial waveform of ADD (CH1)	Magnified waveform of ADD (CH1)

a) ALT MAG of a waveform of CH1

- i) Set the VERTICAL MODE to other than CH2, and display the waveform of CH1.
- ii) Select the MAG POINT LED by the SELECTOR switch, and let the LED light.
Move the cursor to a magnified point by the VARIABLES rotary control.
- iii) Press the ALT MAG switch.
- iv) Perform the operation ① or ② .

The initial waveform of CH1 remains displayed, and the waveform of CH2 disappears. Then, the waveform magnified from the cursor of CH1 appears instead.

- v) The magnified waveform is displayed at approximately 2 div. below the initial waveform. Use the STOR V POS function to move the waveform upward and downward. The initial and the magnified waveforms are moved by STOR V POS CH1 and STOR V POS CH2, respectively.

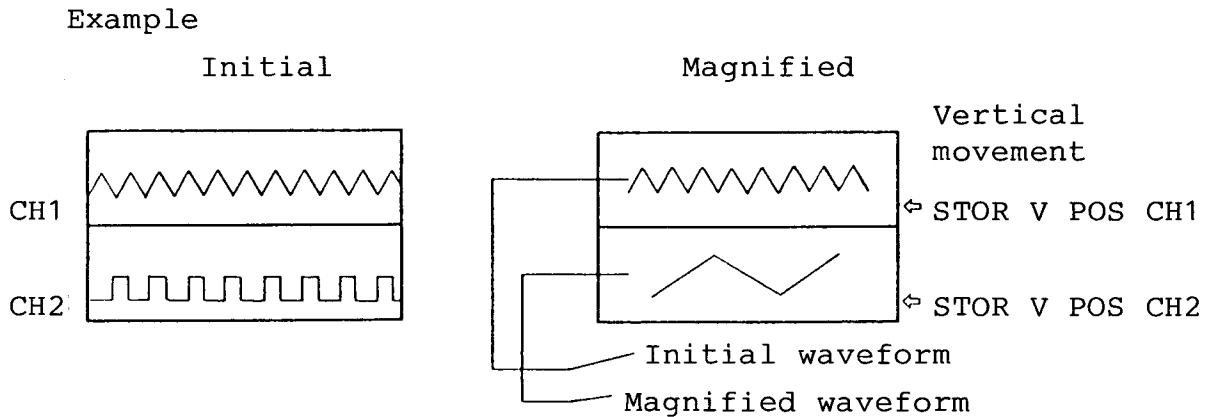

Fig. 8-7

- vi) To display the initial waveform, press the ALT MAG switch again (pulled out).
- b) ALT MAG of the waveform of CH2
- i) Set the VERTICAL MODE to CH2 and display the waveform of CH2.
 - ii) Move the MAG POINT cursor to the magnified point, and press the ALT MAG switch.
 - iii) Perform the operation ① or ②. Then the initial waveform of CH2 remains displayed and the waveform of CH2 is magnified from the position of the cursor of CH2. The magnified waveform is displayed at approximately 2 div. above the initial waveform.
 - iv) The magnified and the initial waveforms are moved vertically by STOR V POS CH1 and STOR V POS CH2, respectively.

Example

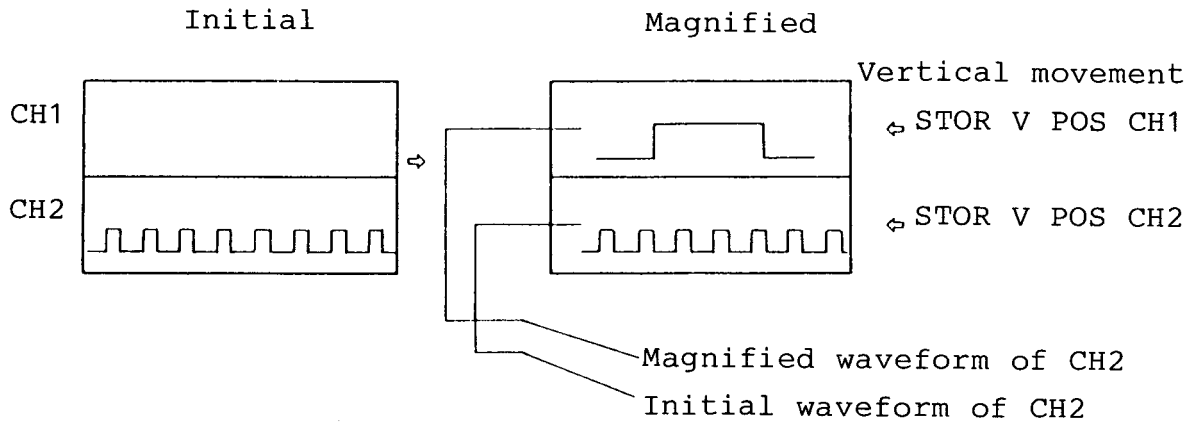

Fig. 8-8

- v) To display the initial waveform, press the ALT MAG switch again (pulled out).

NOTE:

ALT MAG display of SAVE memory waveform
Set the VERTICAL MODE switch to CH1. Select the save memory number to be displayed by the SAVE# switch in the ALT MAG mode. Then set the VERTICAL MODE switch to DUAL, so that the waveform data of the save memory is displayed. Thus, the ALT MAG of the SAVE memory can be made by the operation (a).

④ Magnification by the TIME/DIV switch and the X10 MAG switch

When the magnifying rate is smaller than 50 times in the magnification of the HOLD waveform by the TIME/DIV switch, further magnification is available when the X10 MAG switch is used together.

- a) The HOLD waveform is magnified by the TIME/DIV switch.
- b) Press the X10 MAG switch. Then, the waveform magnified in the above step a) is further magnified by 10 times.

When the magnifying rate exceeds 100 times, rate is set to 100 times.

(12) Interpolation

When the horizontal magnification ratio is made greater, a sine wave may be displayed as staircase waveform or pulse waveform may be difficult to view on the CRT. In this case, the interpolation function provides an easy-to-video waveform on the screen. There are two interpolation functions, the linear interpolation and the sine interpolation. The selection of the modes is switched by pressing the INTERPOLATION switch as follows.

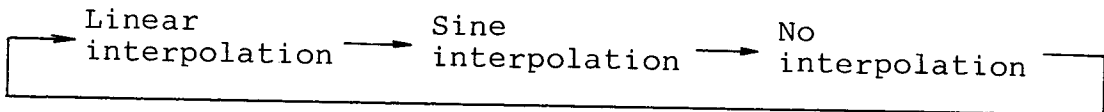

The selected interpolation mode is displayed on the sweep scale factors, lower right of the CRT, as a symbol.

(Refer to item 8.1 (2) ② .)

Select the linear interpolation for a pulse input signal and the sine interpolation for a sine wave.

- ① Display the initial waveform, and set to the HOLD mode.
- ② Magnify the initial waveform by the ALT MAG, X10 MAG, or TIME/DIV switch, and display the waveform to be interpolated on the CRT. (For the operation method of the horizontal magnifying display, refer to (10) Horizontal magnifying display.)
- ③ Each pressing the INTERPOLATION switch executes the interpolation as follows.

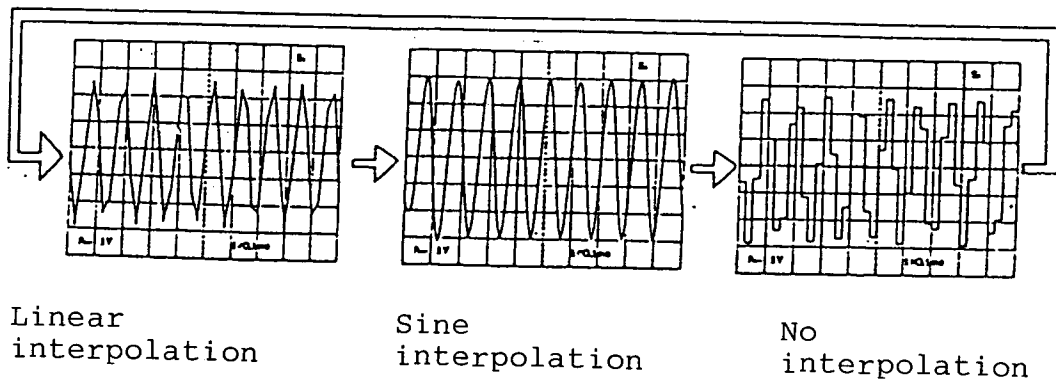

There are two horizontal magnification methods: the normal magnification and the ALT MAG magnification. When the ALT MAG switch is turned to off after the interpolation is executed in the ALT MAG mode, the interpolation is completed, resulting in the normal magnification. When the ALT MAG switch is turned to on with the interpolation being executed in the normal magnification mode, the switch operation is ignored.

The interpolation is completed by changing the VERTICAL MODE, selecting the SINGLE operation, or turning off the HOLD switch. At this time, the instrument performs the specified operation after clearing the display waveforms, the SAVE A and B memories. As for the waveform stored in the ROLL mode and the waveform stored and saved in the ROLL mode, the interpolation is not executed.

NOTES:

When interpolation is executed, some data are destroyed by the calculation and the display of result. Note the following items before performing interpolation.

- (a) When the interpolation is executed once, data of the save memories A and B are destroyed.

Therefore, store the important waveform to the save memories 1 to 15 in the IC memory card.

- (b) When the interpolation is executed with the ALT MAG switch set to off (pulled), the previous waveform on the CRT is destroyed. Further after the interpolation is executed once, the settings of the ALT MAG, X10 MAG, DISP SAVE, and MAG POINT switches can not be changed.

Moreover the horizontal magnification by the TIME/DIV switch is not executed. Therefore, save the waveform in the IC memory card before interpolation.

- (c) Set the ALT MAG switch to on (press in).

When the interpolation is executed with the VERTICAL MODE switch set to CH1, DUAL or CHOP, the measured waveform of CH2 is destroyed.

- (d) When interpolation is performed with the ALT MAG switch set to on and the VERTICAL MODE switch set to CH2, the measured waveform of CH1 is destroyed.

- (e) It is recommended to check the point of the initial waveform to be interpolated by MAG POINT A and the horizontal magnifying ratio before the execution of interpolation.
- (f) When the sine interpolation is executed, calculation errors are included on 1 div each at both sides of the screen.
- (g) When the sine interpolation is performed for the waveform with 2.5 sampling points in one cycle, the amplitude is smaller than that of the initial waveform by approximately 3 dB.

(13) Battery back-up function

The instrument has a battery back-up function. Therefore, the waveform data stored in the save memory and the measurement conditions data can be stored for approximately 72 hours after turning off the power of the instrument. To use this function properly, consider the following notes.

NOTES:

- a) The SAVE data can be stored only when the DISP SAVE switch is off in case of a power failure.
- b) To store data more than for 72 hours, it is necessary to charge the battery backup element for more than approximately 10 minutes before turning off the power. To store the SAVE data, be sure to turn on the power for more than 10 minutes, before turning off the power.

(14) IC memory card

- ① IC memory card and save memory number
15 waveforms can be saved in the IC memory card.
When saving the waveform in the IC memory card, select the save memory number from S1 to S15 by the SAVE# switch. The waveform stored in the IC memory card can be used by a personal computer via the IC memory card reader/writer IU-1.

② Battery back-up function of the IC memory card

The waveform saved in the IC memory card is stored by the battery in the card. When the IC memory card is inserted to the instrument and "B" is displayed on the upper right of the screen, change the battery in the card. (The battery's life is approximately three years.) But "B" is displayed only in the STORAGE MODE.

③ Change of the battery in the IC memory card

Insert the card in the instrument, and turn on the instrument. Then change the battery in the card.

The waveform saved in the IC memory card does not disappear. (Otherwise, the saved waveform disappears.)

④ Initialization of the IC memory card

The contents of a newly purchased IC memory card or the IC memory card whose battery is changed with the card removed from the instrument are not stable. Therefore, it is needed to initialize the IC memory card before using it on this instrument. The initializing procedures are as follows.

- i) Insert the IC memory card to be initialized into the instrument.
- ii) Turn the NORM switch to on. (Select the normal storage mode.)
- iii) Turn the DISP SAVE and HOLD switches to off.
- iv) Press the SELECTOR, SAVE#, and SAVE switches simultaneously in the STORAGE MODE selection.
- v) The waveform on the CRT disappears, the LED above the PLOT switch lights, and initialization starts.
- vi) Initialization finishes in approximately 2 seconds. Then, the LED goes off and the waveform on the CRT is displayed again.
- vii) When the IC memory card is abnormal, or the card other than the RAM card is initialized, "CARD ERR" is displayed upper right of the CRT, and initialization finishes.

8.4 General Measurement

(1) Voltage measurement

① ΔV cursor measurement

The measurable area by the ΔV cursors is 3 divisions above and below the center horizontal graticule line.

Set the VOLTS/DIV switch so that a waveform is within the area. When a signal including a DC component is measured in the DC coupling mode, adjust the POSITION control so that the GND trace is within the measurable area.

When the **MEASURE** is selected by the SELECTOR, two horizontal cursors appear on the CRT. The voltage between the reference cursor and the Δ cursor is displayed with "v" on the upper side of the CRT. The voltage becomes "+" when the Δ cursor is above the reference cursor, while it is "-" when the Δ cursor is below the reference cursor.

The cursor selected by the CURSORS REF. Δ .TRACKING switch moves up when the VARIABLES control is turned clockwise, while it moves down when the control is turned counter-clockwise. Therefore, the voltage between two cursors can be measured.

To measure the voltage from the GND line, press the GND switch to display the GND line, and align the reference cursor with the GND line. Switch the input coupling mode to DC, and align the Δ cursor with the level to be measured.

ΔV cursor measurement for AC voltage

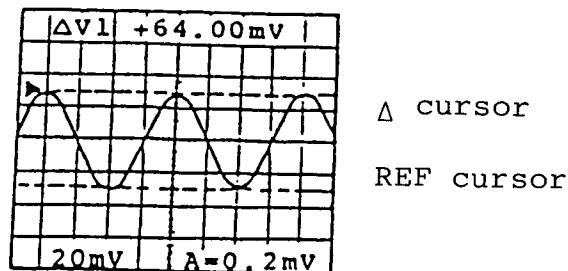

NOTES:

When the DUAL mode is selected in the NON STORE mode, the measurement value of CH1 ($\Delta V1$) is displayed. In the STORAGE mode, $\Delta V1$ or $\Delta V2$ is selected by CH1 or CH2 switch.

② **Automatic Vpp measurement**

When **MEASURE** is selected by the SELECTOR, the cursor ΔV is displayed. When the SELECTOR is pressed 3 times more, the value measured automatically is displayed together with "PP" at the upper part of the CRT.

In case of the automatic Vpp measurement, the absolute value of the difference between the maximum and minimum voltages is calculated. The amplitude capable of being calculated is up to 10 div, ± 5 div from the center of screen. Therefore, when a waveform having amplitude of less than 10 div, the calculated value becomes 10 times of VOLTS/DIV.

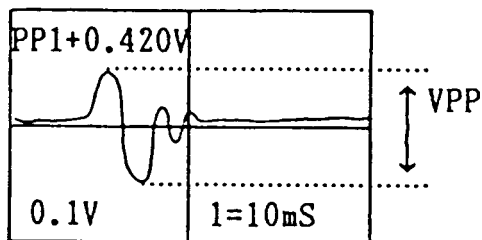

NOTES:

The automatic Vpp measurement can not be selected in the NON STORE mode, ROLL mode, or when the HORIZONTAL MODE is X-Y.

③ Visual measurement

DC voltage (after shifting)

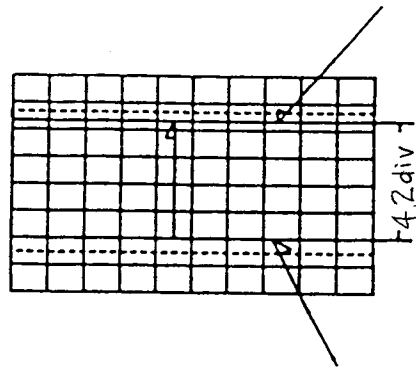

Zero level (reference line)

Set the GND switch to GND and obtain the base-line trace. Set the AC-DC switch to DC and set the VOLTS/DIV switch to obtain an optimum amplitude waveform. Since the trace shifts by the amount of DC voltage, the DC voltage of the signal can be obtained by multiplying the shift by the indicated value of VOLTS/DIV. When VOLTS/DIV is 50 mV/DIV, then $50 \text{ mV/DIV} \times 4.2 = 210 \text{ mV}$ (However, if the 10X probe is in use, the true value of the signal becomes 10 times the value, it will be $50 \text{ mV/DIV} \times 4.2 \times 10 = 2.1 \text{ V}$).

(2) Time and frequency measurement

① ΔT cursor measurement

When the **MEASURE** is selected by the SELECTOR, the ΔV cursor appears on the CRT.

Then, when the SELECTOR is moved downward once so that the ΔT cursor measurement mode is established, the measurement value will be displayed with ΔT on the upper side of the CRT.

The measurable area by the ΔT cursor is 4 divisions to each side from the center vertical graticule line.

Set the TIME/DIV switch so that the desired portion of a waveform is as large as possible.

The two cursors selected by the CURSORS REF $\cdot\Delta$ TRACKING switch can be shifted by the VARIABLES control.

The positive or negative polarity corresponds to the two cursor positions;

+: The Δ cursor is located on the right side of the reference cursor.

-: The Δ cursor is located on the left side of the reference cursor.

Clockwise rotation of the VARIABLES control moves the cursor to the right; counterclockwise rotation moves it to the left.

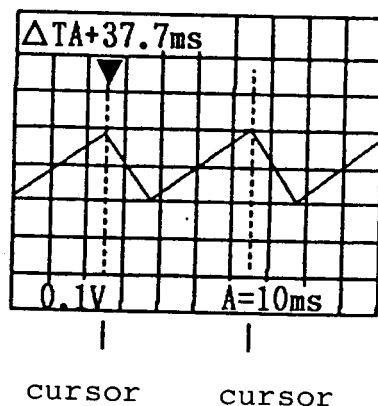

NOTES:

- a) When the HORIZONTAL MODE is X-Y, or when the HORIZONTAL MODE is ALT in the NON STORE mode, the ΔT cursor measurement can not be selected.
- b) The measurement value is displayed in divisions when the TIME switch and the VARIABLES control function produce an uncalibrated sweep. (UNCAL state, CRT display:>)

② **1/ ΔT cursor measurement**

When the **MEASURE** is selected by the SELECTOR, two cursors will appear on the CRT. When the SELECTOR is moved down twice, 1/ ΔT is displayed on the upper side of the CRT. When the two cursors are set to the peaks of the waveform corresponding to one period by the VARIABLES control, the reciprocal number of Δ -time between two cursors is displayed with 1/ ΔT on the upper side of the CRT. Clockwise rotation of the VARIABLES control moves the cursor to the right; counterclockwise rotation of the control moves the cursor to the left.

NOTES:

- a) When the HORIZONTAL MODE is X-Y, or when the HORIZONTAL MODE is ALT in the NON STORE mode, the 1/ ΔT cursor measurement cannot be selected.
- b) The measurement value is displayed in divisions when the TIME switch and the VARIABLES control function produce an uncalibrated sweep. (UNCAL state, CRT display:>)

③ **Automatic FREQ measurement**

When **MEASURE** is selected by the SELECTOR, the cursor ΔV is displayed. When the SELECTOR is pressed 4 times more, the measured frequency is displayed together with FREQ at the upper part of the CRT.

The automatic FREQ measurement is interlocked with trigger and the measurement is executed from the trigger point.

Therefore, the measurement of a special frequency of a complex waveform is possible by changing a trigger level. For an example, when the signal as shown above is input, the frequency of the entire waveform is measured when triggered at point A. Also, the frequency having a pulse of great amplitude is measured when triggered at point B.

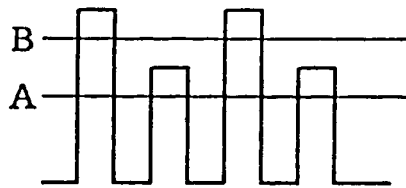

NOTES:

- a) The automatic FREQ measurement is executed for the trigger signal selected by the TRIGGER SOURCE or X switch. As this measurement is interlocked with trigger, the measurement is not executed when not triggered. When the input signal is less than 25 Hz or the signal is not triggered, "FREQ...." is displayed.
- b) The automatic FREQ measurement is not executed in the NON STORE mode, ROLL mode, EXT CLK mode or when the HORIZONTAL MODE is B or X-Y.

④ Visual time measurement

The illustration shows one period of time between A and B, which represents 2.0 DIV.

When the sweep time is 1 ms/DIV, the period is given by

$$1 \text{ ms/DIV} \times 2.0 = 2.0 \text{ ms} (2.0 \times 10^{-3} \text{ s})$$

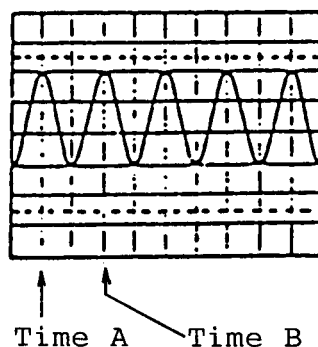

⑤ Visual frequency measurement

The above result, 2.0 ms (2.0×10^{-3} s), is converted so that the frequency is given by $1/(2.0 \times 10^{-3}) = 500$ Hz.

(3) How to trigger

(a) Operation of the AUTO trigger function

When the TRIGGER MODE switch is set to AUTO, the instrument automatically displays a sweep if an input signal is not applied. The trigger level is set according to the amplitude of input signal as shown in Figs. (a) and (b). The AUTO TRIGGER LEVEL setting function eliminates troublesome triggering.

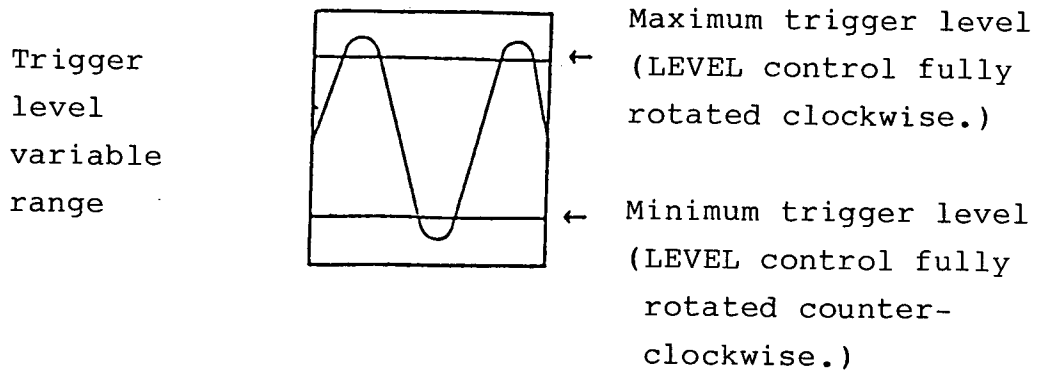

(a) Input signal of large amplitude

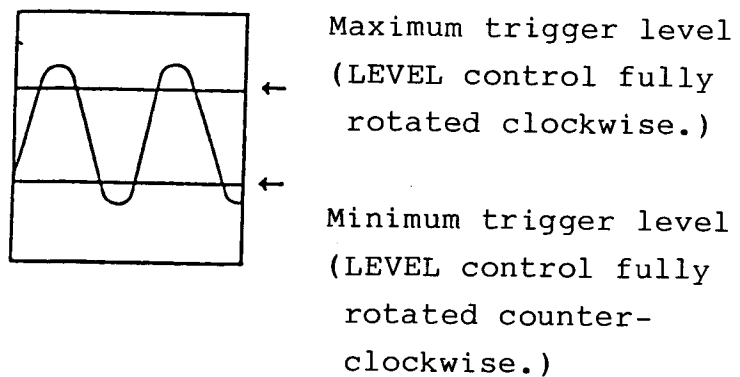

(b) Input signal of small amplitude

When the TRIGGER MODE rotary switch is set to NORM, the trigger level is set regardless of the input signal level.

NOTE:

When the TRIGGER MODE rotary switch is set to AUTO, it takes 2 or 3 seconds to obtain a stable trigger since the trigger level is automatically set according to the amplitude of an input signal.

(b) Operation of the TRIGGER LEVEL control

In the case shown in Fig. (a) where waveforms are greatly different in amplitude, the waveform is doubled if the TRIGGER LEVEL control is not set properly. In the case where the trigger level is selected by line Y, two waves, one starting with A, advancing to B, C, D, E, F,... and the other starting with E, advancing to F, G, H, I..., will appear alternately on the screen. They will be doubled as shown in Fig. (b).

In such a case, rotate the LEVEL control clockwise until the trigger level comes to Y' line. Then the waveform on the screen becomes the one as shown in Fig. (c) which starts with B and advances to C, D, E, F,... and allows triggering.

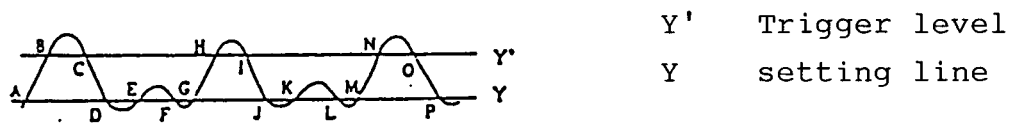

(a) Signal waveform



(b) When the trigger setting level is Y



(c) When the trigger setting level is Y'

Triggering of complex waveforms

(c) Operation of the HOLDOFF function

① In case of measuring a high frequency signal

Slight jitter may occur on a high frequency signal of approximately 5 MHz or more. In this case, adjust the HOLDOFF control so that the jitter is eliminated and a stable trigger is obtained.

② In case of measuring a complex waveform as shown in (a)

It is possible that the triggering is doubled as shown in (b) by the TRIGGER LEVEL control. In such a case, light the HOLDOFF by the SELECTOR and adjust the VARIABLES control to obtain the proper waveform as shown in (c).



(a) Signal waveform



(b) Before using
HOLDOFF



(c) After using
HOLDOFF

Triggering of complex waveforms

(d) Operation of the TRIGGER LOCK function

Triggering can be doubled when the sweep range is changed after performing the HOLDOFF adjustment.

In such a case, light the HOLDOFF by the SELECTOR.

When the TRIGGER LOCK lamp is lit with the waveform triggered, the triggering is not doubled if the sweep range is changed.

If the TRIGGER LOCK function is not required, press the TRIGGER LOCK switch again so that the lamp goes off and this function is released.

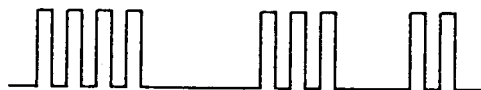

(a) Waveform triggered by HOLDOFF, etc.

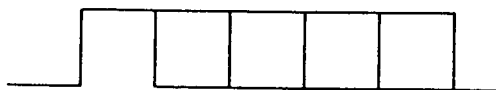

(b) Magnified with TRIGGER LOCK OFF



(c) Magnified with TRIGGER LOCK ON

Triggering of complex waveforms

NOTE:

- a) The A TIME/DIV range and the TIME VARIABLES range in the TRIGGER LOCK mode cannot be set to the slower than that when the signal is locked.
- b) The EXT CLK mode can not be selected in the TRIGGER LOCK mode.

(e) Operation of the TV trigger SYNC function

① TV video signal

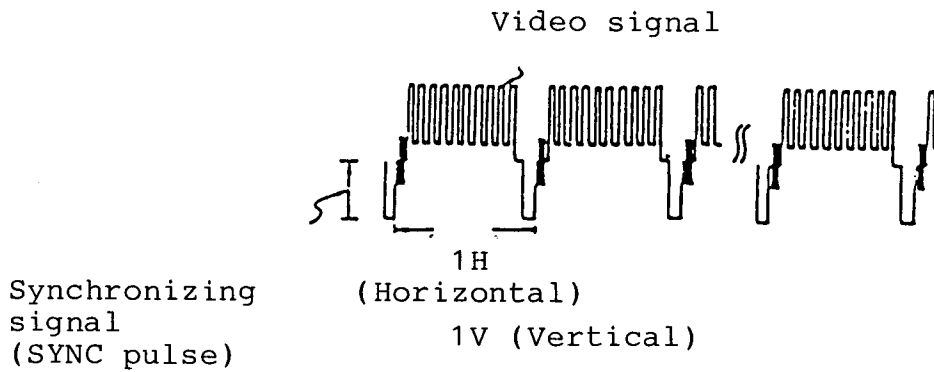

In video work, a composite video signal containing a video signal, a blanking signal, a pedestal signal, and a sync signal is often measured.

② Operation

To observe a vertical signal

To observe a horizontal signal

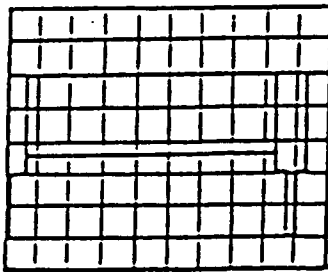

TRIGGER MODE: TV-V

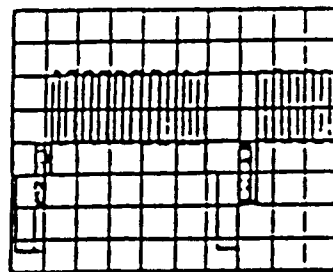

TRIGGER MODE: TV-H

The polarities of the video and sync signals are automatically set. The trigger level setting is not required in the TV mode.

(4) Measurement of the waveform before the trigger point

Although a conventional oscilloscope displays the trigger point only at the left end of the screen since the sweep starts at the trigger point of the signal, the instrument can display the trigger point anywhere on the screen in 0.1 div steps, using the PRETRIGGER function in the STORAGE mode so that it is possible to measure the waveform before trigger point precisely.

(a) When the PRETRIGGER lamp is selected by the SELECTOR switch, the position of the trigger point is displayed (div).

(b) The position of the trigger point is set by the VARIABLES control.

The trigger point can be set to any point ranging from 0 div (left end) to 9.9 div (right end) in 0.1 division intervals.

Example: In the case of 4.0 div setting, the signal before the rising edge of the waveform (the triggered point) can be observed as shown below.

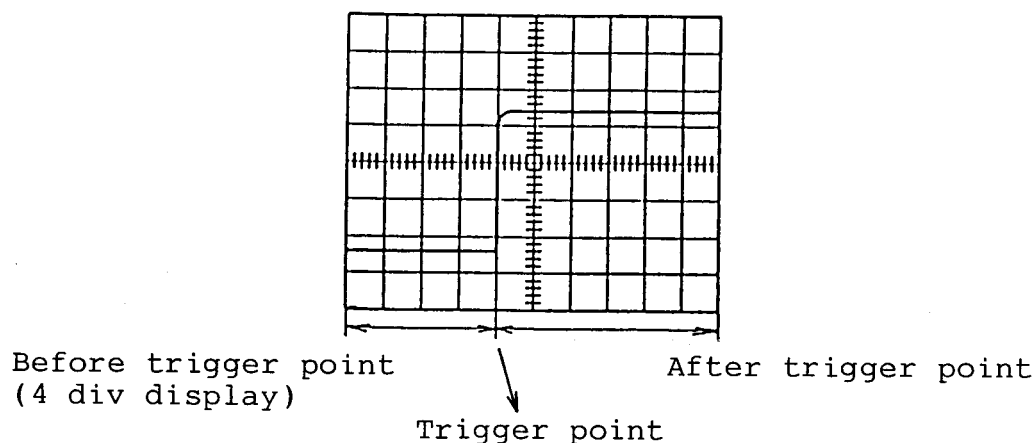

NOTE:

The PRETRIGGER function is not activated in the faster range than $2 \mu\text{s}/\text{DIV}$.

In the HOLD mode, the trigger point can not be changed.

(5) Operation of the AUTO range function

In the normal measurement, the sweep range is set by the TIME/DIV switch. When the AUTO lamp is lit by pressing the AUTO switch with the signal triggered, the input signal is detected, the sweep range is automatically set, and the waveform of 1.6 to 4 cycles is displayed on the CRT. This is recommended when the time relation of an input signal is unknown or the input frequency changes with time.

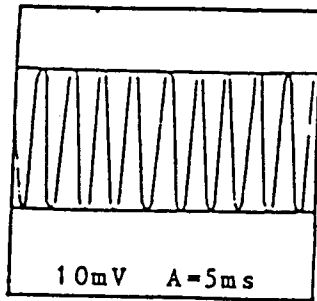

(a) Before using AUTO range

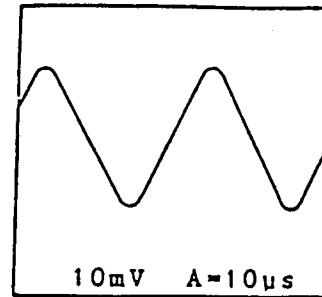

(b) After using AUTO range

NOTES:

- a) The AUTO range does not function when the trigger is not obtained. The AUTO range functions with the trigger signal selected by the TRIGGER SOURCE OR X and TRIGGER MODE switches.
- b) Since the operable time range is 5 ms/DIV to 50 ns/DIV, the signal of 100 Hz or less, or 8 MHz or more is not displayed as the waveform of 1.6 to 4 cycles. The time range is set to 5 ms/DIV for the signal of 100 Hz or less or in case of out of trigger, and set to 50 ns/DIV (maximum) for the signal of approximately 8 MHz or more.
- c) The HORIZONTAL MODE switch should be set to A.
- d) When the AUTO range functions with the VERTICAL MODE switch set to DUAL, the dual trace operation is always performed in the CHOP mode. For measuring the waveforms at high speed, release the AUTO range function by setting the A AND B TIME/ DIV switch to the high speed mode or the low speed mode.

- e) In case of measuring a complex waveform such as a TV signal, it may take several seconds to perform the AUTO range function.
- f) In case of measuring a complex waveform, the time range can be automatically changed and the waveform cannot be measured easily. In this case, release the AUTO range function.
- g) To release the AUTO range, set the A AND B TIME/DIV switch to either side.
- h) In the X10 MAG mode, the waveforms of 1.6 to 4 cycles are magnified by 10 times.

(6) Operating procedure of the delayed sweep

① NON STORE mode

A delayed sweep is used to magnify any portion of a complex waveform in the horizontal direction.

Press the A switch of the HORIZONTAL MODE to trigger the A sweep and set the switches as follows.

HORIZONTAL MODE : ALT

A TIME/DIV : As desired

B TIME/DIV : Set to the time range to be magnified.

A and B sweeps appear simultaneously on the CRT, DELAY is automatically set by the SELECTOR, and the two cursors will appear.

The two cursors will move continuously by the VARIABLES control. Bring the cursors to the position to be magnified. Then, the waveform between the cursors is magnified to occupy the full area of the screen.

The time from a starting point of the A sweep to that of the B sweep is displayed on the upper left side of the CRT. To measure the magnified waveform only, set the HORIZONTAL MODE to B.

After
magnifi-
cation

Before
magnifi-
cation

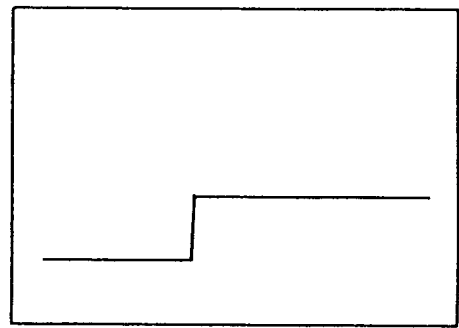
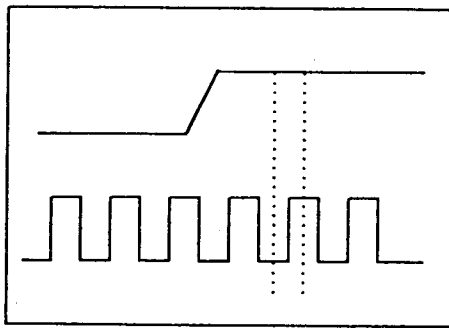

(a) HORIZONTAL MODE: ALT

(b) HORIZONTAL MODE: B

The B sweep trace can be shifted vertically approximately ± 3 divisions with respect to the A sweep trace for the convenience of measurement by the A/B SEP switch. The vertical variable range is initialized to approximately +2 divisions with respect to the A sweep trace. By setting the VERTICAL MODE to the dual mode in the ALT sweep mode, two more traces, four traces in total, appear on the CRT.

NOTES:

- a) Since traces are alternately displayed in the ALT sweep mode, flicker can occur in the slow sweep rate. To avoid this, set the TIME/DIV switch to the 0.2 ms/DIV or higher.
- b) The time range of the B sweep is designed to be always higher than that of the A sweep (except in the 50 ns/DIV). Prior to change of the time range of the A sweep with the HORIZONTAL MODE switch set at ALT or B, set the HORIZONTAL MODE to A again.
- c) As the magnification ratio increases in the delay sweep mode, the intensity decreases. If the focus of the trace is adjusted to be optimum at this time, a proper focus cannot be obtained for characters, which is not suitable for photographing. Therefore, do not increase the intensity too much, or blank characters for photographing.

d) The interval between two cursors in the delay sweep mode is designed to be always 0.5 div or more on the CRT, so that easy observation is ensured when the magnification ratio is increased.

Therefore, all the waveform between the cursors is not magnified when the magnification ratio is increased. To verify what part of the A sweep is magnified, check the delay time displayed on the upper left side of the CRT and the A sweep time.

e) The cursors which indicate delay position disappear when the X10 MAG mode is established.

② STORAGE mode

This mode is used for sampling the portion of a signal delayed by a certain time from the trigger point of the A sweep at a high speed and measuring the signal precisely. Select the A switch of the HORIZONTAL MODE and trigger the signal and set the TIME/DIV switch as follows.

A TIME/DIV : Set this control so that the delay time is within 10 divisions on the CRT.

For example, if the delay time is 8 ms, set this control at a slower range than 1 ms/DIV.

Then, set the HORIZONTAL MODE to B, and the SELECTOR is automatically set to DELAY. The waveform is changed to the B sweep waveform and the TIME/DIV display is changed to B TIME/DIV.

a) Set the delay time displayed at the upper left side of the CRT to the desired value by the VARIABLES control.

The waveform start point at the left side of the screen is delayed by the set time from the trigger point of the A sweep.

b) Set the B TIME/DIV to the time range to be measured.

NOTES:

- a) The B sweep can be set for the time range of 2 μ s/DIV to 50 ms/DIV in the NORM or the AVG mode, and 0.1 ms/DIV to 50 ms/DIV in the ENV mode.
- b) As in the NON STORE mode, the B sweep time range is not made slower than the A sweep time.
When the HORIZONTAL MODE is set to B, the A TIME/DIV can not be changed. When changing the time range of the A sweep, reset the HORIZONTAL MODE switch to A.
- c) When the PRETRIGGER is set in the B sweep mode, the time from the trigger point of the A sweep to the PRETRIGGER corresponds to the delay time set previously.
- d) The EXT CLK mode can not be selected in the ALT or B sweep mode. The EXT CLK mode is released when the HORIZONTAL MODE switch is set to ALT or B in the EXT CLK mode.

(7) Measurement of single shot phenomena

To measure a single-shot signal and a complex waveform such as an impulse wave, an audio signal, noise from a switch, etc., the STORAGE mode is usually used. However, the following measurement is sometimes possible in the NON STORE mode.

① Single sweep measurement for a waveform to be easily triggered

Set the HORIZONTAL MODE to A, and the TRIGGER MODE to NORM. Connect a vertical signal to be observed or a repetitive waveform having the same amplitude as the above signal, and rotate the TRIGGER LEVEL control to obtain a proper triggering.

Select SINGLE by the SELECTOR, press the SINGLE RESET switch, and check that the single sweep is performed.

Disconnect the vertical signal from the instrument (press the GND switch, for example), press the SINGLE RESET switch again, and check that the SINGLE RESET lamp lights. When the vertical signal is connected again, the single sweep is performed. At the time, the SINGLE RESET lamp goes off.

② **Single sweep measurement for a waveform hard to be triggered**

Set the TRIGGER MODE to AUTO, the HORIZONTAL MODE to A, and select SINGLE by the SELECTOR.

Press the SINGLE RESET switch so that the single sweep is performed.

NOTES:

- a) If the TRIGGER LEVEL control is rotated, the sweep is performed even when no signal is supplied. After the SINGLE RESET lamp lights, do not rotate the TRIGGER LEVEL control.
- b) For a general single shot measurement, set the TRIGGER MODE to NORM.
- c) When the HORIZONTAL MODE is set to ALT or B, the single sweep cannot be performed.

(8) Operation of the BW LIMIT function

(only valid for a trigger signal in the STORAGE mode)

When it is hard to measure or trigger a signal because a high-frequency component of more than 20 MHz is superimposed on the signal, use the BW LIMIT function.

By the BW LIMIT function, the component of approximately 20 MHz or more of the sync signal can be eliminated.

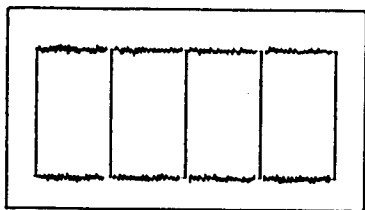

(a) Before the BW LIMIT functions

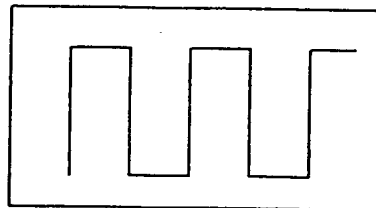

(b) After the BW LIMIT functions

NOTE:

When the BW LIMIT function is used, the frequency bandwidth is approximately 20 MHz.

(9) System reset

In case of abnormal AC power, etc., the built-in microprocessor can malfunction. In this case, press the POWER switch to OFF, and then ON after three seconds or more to reset the microprocessor. Allow approximately twenty seconds for the instrument to be operated after completion of the automatic calibration.

9. DIGITAL PLOT OUTPUT TO THE XY PLOTTER

All the data displayed on the screen is output to the XY plotter only by connecting this instrument and the XY plotter with the GPIB cable.

The operation of the instrument is described below.

For the operation of the XY plotter, refer to the operation manual attached to the plotter.

9.1 Applicable XY Plotter

HP7470A (GPIB specifications) or completely compatible unit.

9.2 Specifications of Plot

(1) Letters and cursor

All the letters and cursor displayed on the screen are plotted.

(2) Waveform data

All the waveform data displayed on the screen is plotted. In the magnification mode, the magnified portion only is plotted.

(3) Grids

The grids of the horizontal axis of 10 divisions and the vertical axis of 8 divisions are plotted. The scale of 0.2 div unit on the horizontal and vertical center grids is plotted.

(4) Number of plotted screws

One, two or four screws are plotted on a paper of A4 size.

(5) Color of plot

Scale, waveform, cursors and characters are plotted in different colors.

(6) Example of plot

Fig. 9-1 illustrate examples of the plot outputs.

9.3 Connection and Setting

(1) Connection

Use the GPIB for the connection with the XY plotter. Connect the connector on the rear and the XY plotter with the GPIB cable.

(2) Setting of digital plot mode

Press in the **D PLOT** switch on the rear, and set the Y-T mode by the X-Y/Y-T switch. Then the plot to the XY plotter is possible. When the switch is pulled, the instrument is placed in the mode that the analog data is output to a recorder, etc. (see 8.3-(8)), and the output to the XY plotter is not available.

Be sure to set the X-Y plotter in the LISTEN ONLY mode. In the other modes, plotting is not executed.

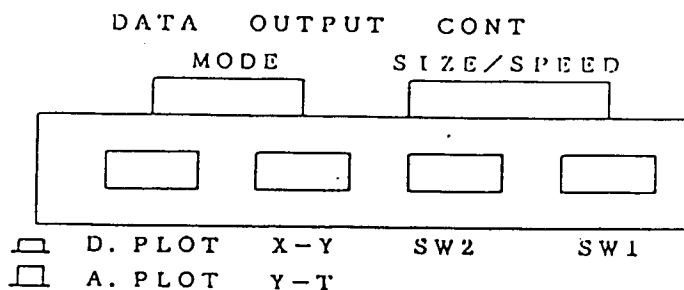

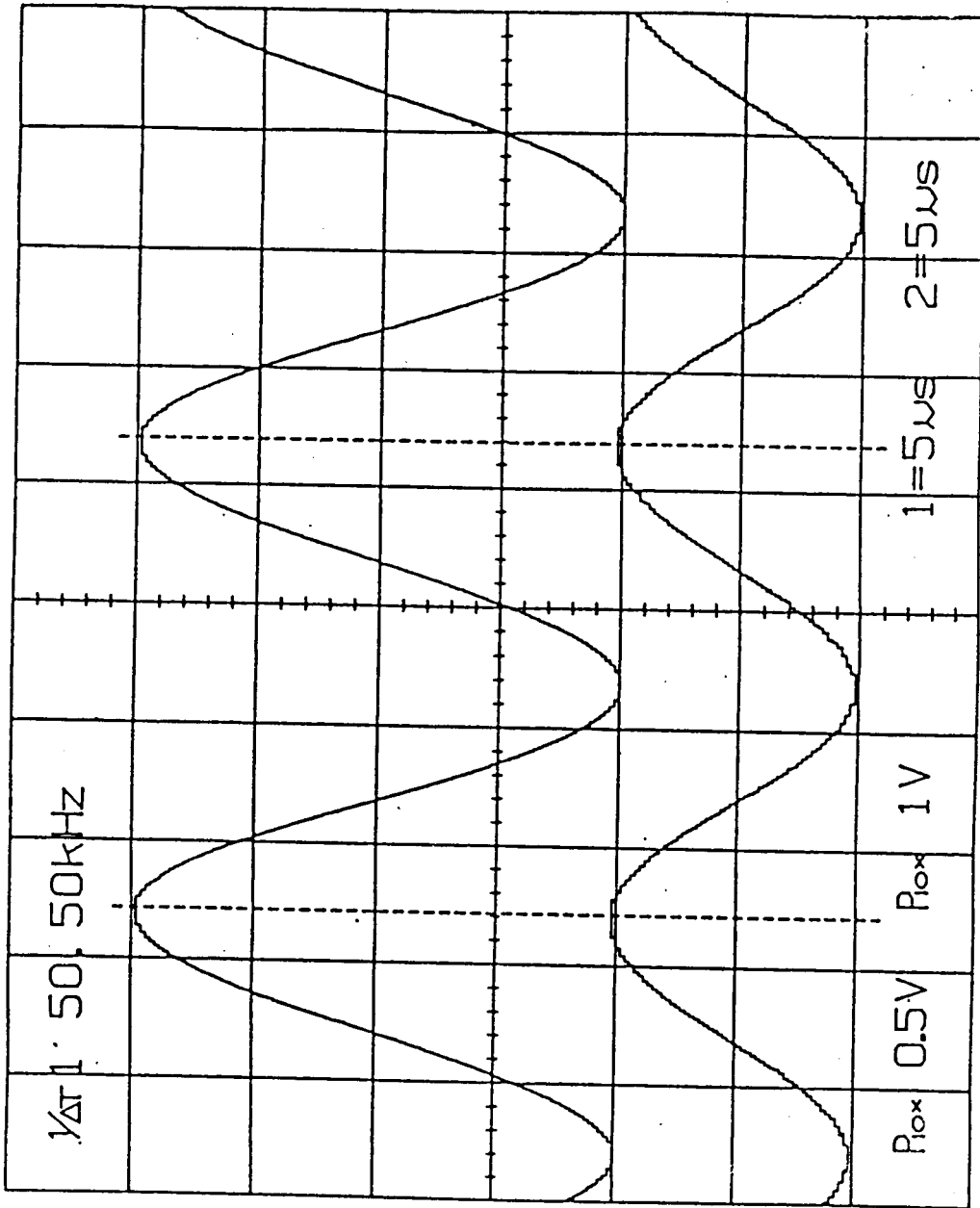

Fig. 9-1 Example of a plot output display

(3) Setting of the number of plotted screens

Set the number of plotted screens by the **SW1** and **SW2** switches on the rear. (Table 9.1 shows the relationship between the combination of the **SW1** and **SW2** switches and the number of plotted screens.)

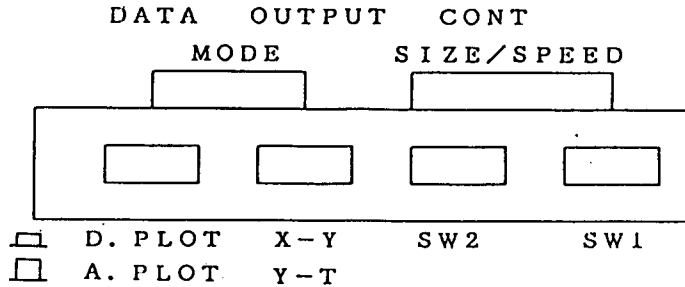
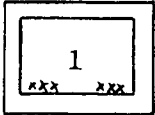
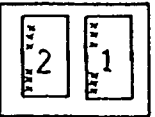
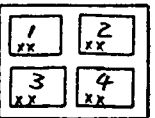
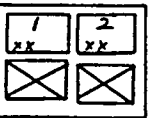

Table 9.1 Relationship between the **SW1** and **SW2** switches and the number of plotted screens.

SW2	SW1	No. of screen	Example
OFF	OFF	1	
ON	OFF	2 (Vertical plotting)	
OFF	ON	4	
ON	ON	2 (Vertical plotting)	

Note 1: Arrow indicates the inserting direction of paper.
(In case of 7470A)

2: Figures indicate the order of plotting.

3: xxx indicates the plotting position of scale factor.

9.4 Operation

(1) Execution of plotting

When the instrument is in the HOLD mode, and not in the SINGLE operation, press the **PLOT** switch. Then, the plotting starts according to the setting of the number of plotted screens. While the plotting is being executed, the green lamp above the switch lights. When the plotting finishes, the lamp goes off and the pen is released.

When the number of plotted screens is set prior to the execution of plotting (before the **PLOT** switch is pressed), plotting is executed according to the new setting.

(2) Release from plotting operation

When the **PLOT** switch is pressed again during the plotting operation, the plotting operation stops.

Thus an unnecessary plotting operation can be stopped.

9.5 Plotting Colors

Scale, waveform, cursors and characters are plotted in different colors. (See Table 9.2.)

Item		Pen No.
Scale		PEN 1
Waveform	CH1	PEN 2
	CH2	PEN 4
Cursor		PEN 3
Characters	Parameter	PEN 1
	Measured data	PEN 1
	CH1 scale factor	PEN 2
	CH2 scale factor	PEN 1
	Sweep scale factor	PEN 1
	X-Y display	PEN 1

NOTE:

The contents of Table 9.2 are changed according to the number of X-Y plotter pens.

a) In case of the X-Y plotter capable of using more than 4 pen colors

Same as Table 9.2

b) In case of the X-Y plotter capable of using 2 pen colors

PEN 3 and PEN 4 in Table 9.2 change to PEN 1.

c) In case of the X-Y plotter using one pen color

All the pens in Table 9.2 change to PEN 1.

9.6 Repetition of Plot Sequence

When the plotting of one screen finishes, turn the

X-Y
Y-T

 switch on the rear to ON. Then plotting repeats in the same sequence as before. This operation is released when the switch is turned to OFF. When the operation is released, the plotting sequence returns to 1.

Example:

 = ON,

 = OFF (4-screen plotting)

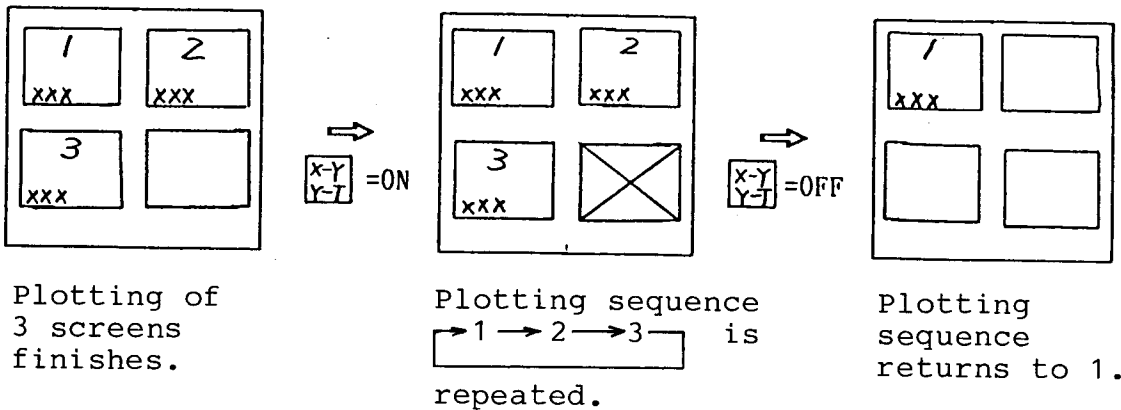

9.7 GPIB Interface

The instrument is provided with the GPIB as a standard function. With this function, it is possible to perform the control by a computer and to input and output the waveform data to the computer. These communication functions can not be used with the output function to the XY plotter.

Do not execute the XY plotter output function (plot output by the PLOT switch) when using the communication function. In this case, be sure to set the D.PLOT switch on the rear to OFF.

9.8 Major Causes of Troubles

- (1) Cable is poorly connected or not connected.
- (2) The power of the XY plotter is off.
- (3) The XY plotter is not in the LISTEN ONLY mode, or in the error state.
(See the operation manual of the XY plotter.)
- (4) The instrument is not in the HOLD mode or in the SINGLE operation mode.
- (5) The DATA OUTPUT CONT switch is not set correctly.
(The D.PLOT switch is ON and the X-Y/Y-T switch is not set to Y-T.)
- (6) A unit other than the XY plotter is connected.

When the XY plotter does not operate normally, check the above items.

10. GPIB

10.1 Introduction

The GPIB is a general purpose interface bus which conforms to the IEEE-488 (1978) GPIB standards, which provides an interface between digital equipment by using exclusive connectors and cables.

10.2 GPIB System

10.2.1 General

The GPIB is used for transmitting and receiving data of different transfer rates between self-contained instruments or devices and the GPIB can support up to 15 independent devices connected in parallel.

Data transmission instructions between the instrument and other independent devices such as a personal computer via the GPIB are described in this manual.

Fig. 10-1 shows a typical system using the GPIB.

While only four instruments are shown, the GPIB can support up to 15 independent devices connected directly to the bus. GPIB system equipment functions are classified into the three following classes: talker, listener and controller.

During interface system operation, the connected equipment operates in one of the corresponding GPIB system functions. A talker is an instrument that can send data to one or more listeners, while a listener is an instrument that can accept data from the talker. A controller is an instrument that determines which of the instruments on a bus will talk and which instruments will listen during any given time interval.

The controller also has the ability to assign itself as either a talker or a listener, whenever the program routine requires.

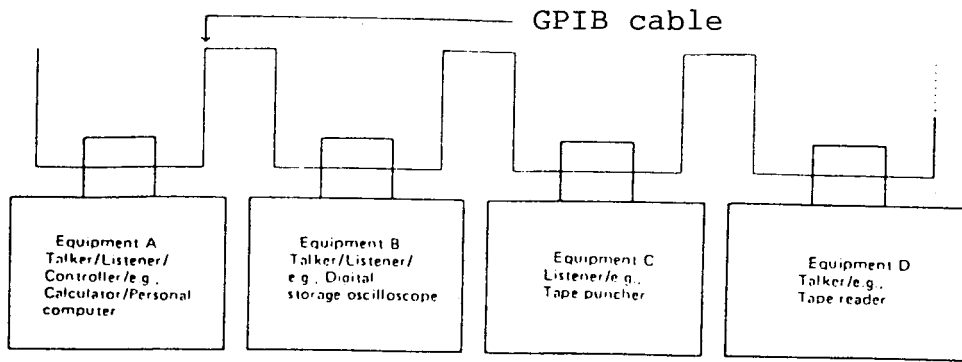

Fig. 10-1 A typical system using the GPIB

10.2.2 Specifications

(1) Message paths and bus structure

Fig. 10-2 shows the 16 signal lines of the GPIB functionally divided into three component buses: an eight-line data transfer bus, a three-line handshake control bus and a five-wire management bus.

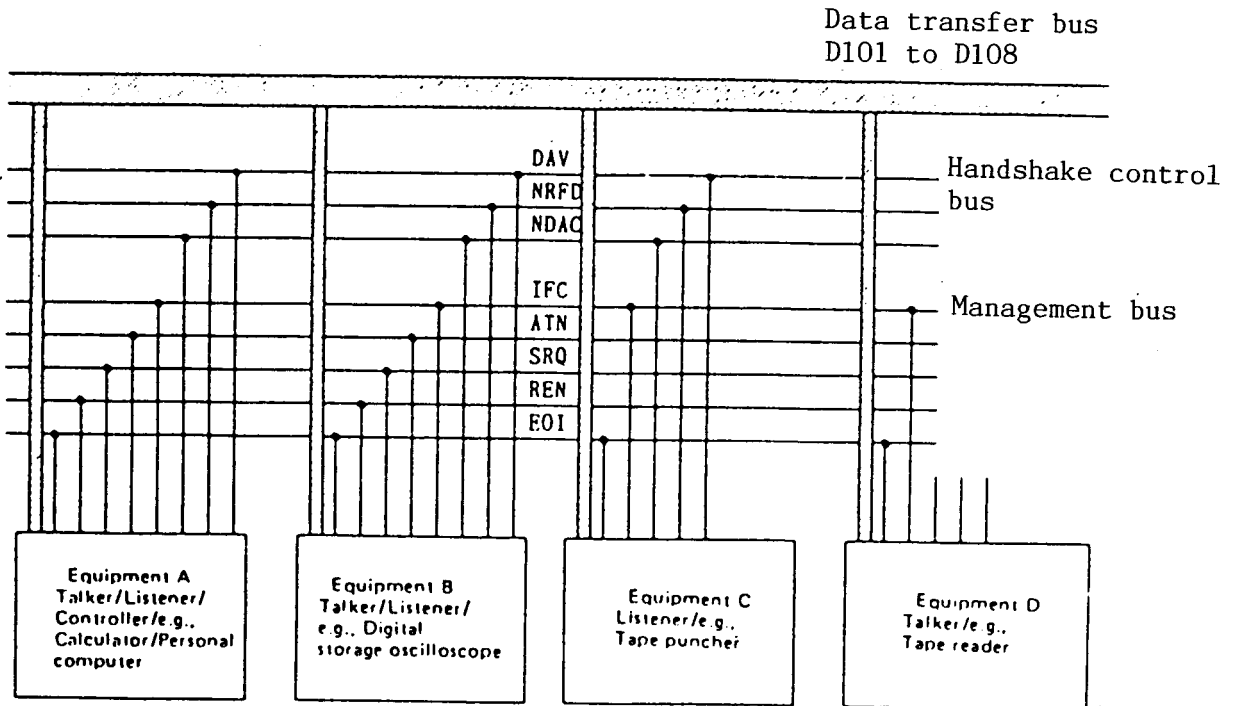

Fig. 10-2 GPIB structure

a) Handshake control bus

i) DAV : Data Valid

Asserts that data on the data bus is valid.

When DAV is LOW: Data is valid for the listener.

When DAV is HIGH: Data is invalid for the listener.

ii) NRFD : Not Ready For Data

A HIGH NRFD indicates that all the assigned listeners are ready to receive the next data byte from the talker.

LOW NRFD: Not ready to receive data.

iii) NDAC : Not Data Accepted

A HIGH NDAC indicates that all assigned listeners have accepted the current data.

LOW NDAC: Does not have accepted the current data.

(The talker will control data bus and DAV lines, while the listener controls NRFD and NDAC lines.)

b) Management bus

i) IFC : InterFace Clear

Only the system controller can generate this IFC signal.

When IFC is LOW for at least 100 μ s, all interfaces for the talker and the listener are in a quiescent state. Then, the control priority is returned to the controller.

ii) ATN : Attention

Only a controller can generate the ATN signal.

LOW ATN: Establishes command mode.

HIGH ATN: Establishes data mode.

iii) SRQ : Service Request

Any instrument connected to the bus can request the controller's attention by sending the SRQ message. The SRQ message can be set only when IFC is HIGH.

iv) REN : Remote Enable

The system controller sends the REN message to an instrument whenever the interface system is operating under remote program control.

v) EOI : End Of Identify

A talker can use the EOI message to indicate the end of a data-transfer sequence, or to execute a polling sequence by a controller.

When ATN is HIGH, the talker sends the EOI LOW message to indicate the last byte of data is transmitted.

c) Data bus

DIO1 to DIO8: Data Input Output

The data bus has eight bidirectional signal lines, DIO1 through DIO8. Information, in the form of data bytes, is transferred over this bus.

A handshake sequence between an enabled talker and the enabled listeners transfers one data byte at a time. Data bytes in either an interface or device-dependent message are sent in a byte-serial sequence over the data bus.

(2) GPIB connector and cable

Physical arrangement of the 24-conductor GPIB connector (located on the rear panel) meets IEEE-488(1978) GPIB standards.

A contact assignments of the cable connector and the device connector shall be as shown in Fig. 10.3.

16 pins are for signal lines and the remaining 8 pins are for ground.

The voltage and current conform to TTL standard and; the voltage shall be less than +5.5 V against GND.

When the voltage is low level of +0.8 V or lower, the signal is set to logic "1" in the TRUE mode.
 When the voltage is high level of +2 V or higher, the signal is set to logic "0" in the FALSE mode.
 Use a double shielded GPIB cable which especially meets the following conditions in IEEE-488(1978) GPIB standards.

- a) Total cable length: 20 m max.
(Total of each cable length)
- b) Single cable length: 4 m max. (One span connection)
- c) Connectable equipment number: 15 sets max.
(Including a controller)

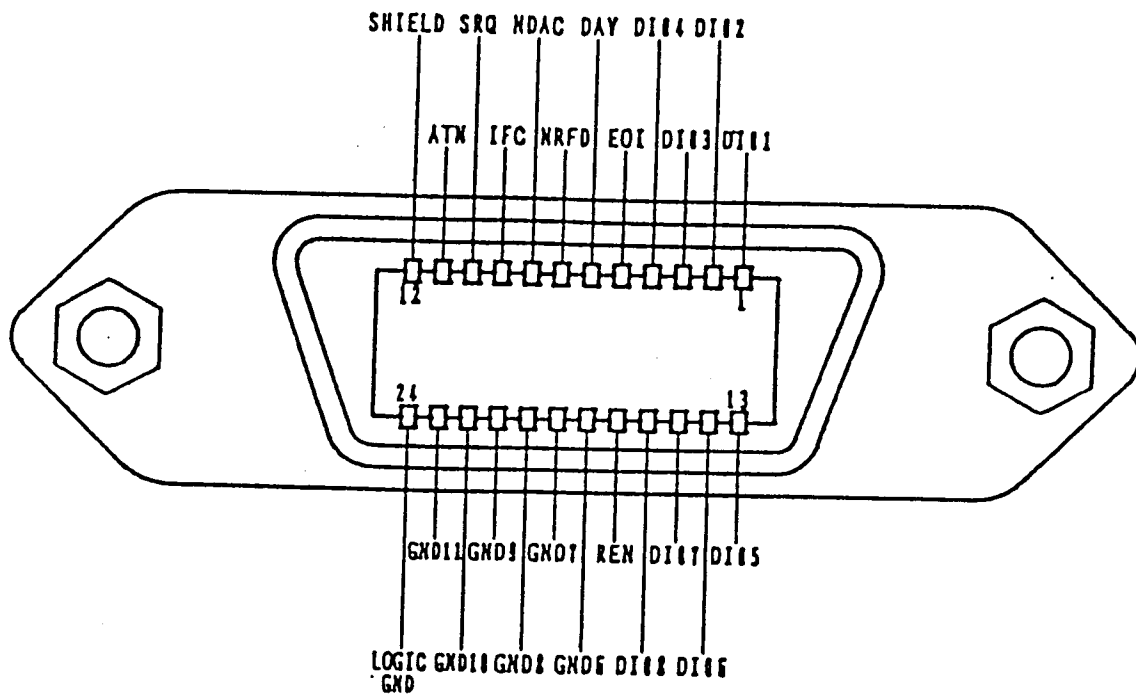

Fig. 10-3 GPIB interface connector

10.2.3 Multiline interface message command

The message command is transmitted from the controller to each device connected with the GPIB when an ATN signal is LOW. Then, the received device starts operations specified in GPIB standard.

Table 10-1 shows Multiline Interface Messages including the output codes for the message command and ASCII codes.

10.3 The GPIB for the Digital Storage Oscilloscope

10.3.1 GPIB functions

Ten interface functions including up to 28 subsets are specified in the IEEE-488 standards. The GPIB may not include all of the functions specified by the standards. Necessary functions, which are selectable according to product applications, are available by selecting combinations of the interface message commands described in Item 10.2.3.

Each subset offers a precise interface function.

Table 10-2 shows the multiline interface message commands for interface functions.

Table 10-2 Interface functions of the instrument

No.	Identification	Function	Relevant interface message	Function of the instrument
1	SH (Source Handshake) SH0, SH1	Transfers message onto data bus.	—————	SH1: Complete capability
2	AH (Acceptor Handshake) AH0, AH1	Receives message from data bus.	—————	AH1: Complete capability
3	T (Talker) T0 to T8 [TE0 to TE8: extended talkers]	Sends data to another device over data bus. (Inc. Serial Poll)	MTA (My Talk Address) MSA (My Secondary Address)	T6: Basic talker Serial poll Unaddress if MLA
4	L (Listener) L0 to L4 [LE0 to LE4: extended listeners]	Receives data from another device over data bus.	MLA (My Listen Address) MSA (My Secondary Address)	L4: Basic listener Unaddress if MTA

No.	Identification	Function	Relevant interface message	Function of the instrument
5	SR (Service Request) SR0, SR1	Requests service asynchronously from controller.	SPE (Serial Poll Enable) SPD (Serial Poll Disable)	SR1: Complete capability
6	RL (Remote Local) RL0 to RL2	Selects remote/local source. (Program control/ Front panel control)	GTL (Go To Local) LLO (Local Lock Out)	RL0: No capability
7	PP (Parallel Poll) PP0 to PP2	Present status information (PPR message) of one bit to controller without being previously addressed to talk.	PPC (Parallel Poll Configure) PPU (Parallel Poll Unconfigure) PPE (Parallel Poll Enable) PPD (Parallel Poll Disable)	PR0: No capability
8	DC (Device Clear) DC0 to DC2	Device(s) in groups or individual are initialized.	DCL (Device Clear) SDC (Selected Device Clear)	DC1: Complete capability
9	DT (Device Trigger) DT0, DT1	Starts each or each group of device(s).	GET (Group Execute Trigger)	DT0: No capability
10	C (Controller) C0 to C28	Sends device address, universal command and addressed command to another device over data bus.	UNT (Untalk) UNL (Unlisten) TCT (Take Control)	C0: No capability

For further details of subsets of SH1, AH1, etc., refer to the IEEE 488 (1978) standards.

(1) Multiline interface message command and operation of the instrument

Tables 10-3 through 10-6 show the multiline interface message command and operation of the instrument.

① Primary Command Group (PCG)

Table 10-3 Address Command Group (ACG)

No.	Command	Function	Operation of the instrument
1	GTL (Go To Local)	Establishes the local mode.	None
2	SDC (Selected Device Clear)	Initializes the selected device.	Initializes GPIB.
3	GET (Group Executive Trigger)	Provides the trigger signal.	None
4	PPC (Parallel Poll Configure)	Establishes the parallel poll mode.	None
5	TCT (Take Control)	Takes over the control of interface.	None

Table 10-4 Universal Command Group (UCG)

No.	Command	Function	Operation of the instrument
1	LLO (Local Lock Out)	Disables switch operations.	None
2	DCL (Device Clear)	Initializes all the bus function.	Initializes GPIB.
3	PPU (Parallel Poll Unconfigure)	Releases the parallel poll mode.	None
4	SPE (Serial Poll Enable)	Establishes the serial poll mode.	Establishes serial poll mode.
5	SPD (Serial Poll Disable)	Releases the serial poll mode.	Releases serial poll mode.

Table 10-5 Listener Address Group (LAG) and UNL

No.	Command	Function	Operation of the instrument
1	LA 0 to 30 (SP to >)	Indicates the address of device to be a listener.	If the designated address meets the address of the instrument, the instrument becomes a listener.
2	UNL (?)	Clears the listener's address.	Clears the listener's address.

Table 10-6 Talker Address Group (TAG) and UNT

No.	Command	Function	Operation of the instrument
1	TA0 to 30 (@ to)	Indicates the address of device to be a talker.	If the designated address meets the address of the instrument, the instrument becomes a talker.
2	UNT (-)	Clears the talker's address.	Clears the talker's address.

② Secondary Command Group

In the case of the instrument, the Secondary Command Group is not employed.

(2) Uniline command and operation of the instrument

Uniline commands are used for the controller to make directly access to all the devices through the bus line (IFC and REN). Uniline command and the instrument functions are shown in Table 10.7.

Table 10-7 Uniline Commands and operation of the instrument

No.	Command	Function	Operation of the instrument
1	IFC (Interface Clear)	Initializes interface.	Clears data bus.
2	REN (Remote Enable)	Enables remote mode.	None (GPIB is always in the remote mode.)

10.3.2 Address switch setting of the instrument

Each device will have a proper GPIB address.

The controller specifies the device function by indicating the corresponding address. The address data is defined by ASCII characters (i.e. Listener/Talker's addresses of the Multi-line Interface Message Command). Table 10-8 shows the address coding for the instrument. Address is set by the Address setting switch of the GPIB on the rear side of the instrument. Addresses of 0 to 30 are selectable.

Address settings must be done with power off.

If the setting is done with power on, the switch setting is invalid.

This switch setting has been set to "1" (Position 6 is ON) at the factory.

Table 10-8 GPIB Address Coding of the Digital Storage Oscilloscope

GPIB Address	Listener's address		Talker's address				DIP switch					
	Charac- ter	Code		Charac- ter	Code		1	2	3	4	5	6
		Hexa- decimal system	Decimal system		Hexa- decimal system	Decimal system	-	2 ⁴	2 ³	2 ²	2 ¹	2 ⁰
0	SP	20	32	@	40	64	NC	0	0	0	0	0
1	!	21	33	A	41	65	NC	0	0	0	0	1
2	"	22	34	B	42	66	NC	0	0	0	1	0
3	#	23	35	C	43	67	NC	0	0	0	1	1
4	\$	24	36	D	44	68	NC	0	0	1	0	0
5	%	25	37	E	45	69	NC	0	0	1	0	1
6	&	26	38	F	46	70	NC	0	0	1	1	0
7	'	27	39	G	47	71	NC	0	0	1	1	1
8	(28	40	H	48	72	NC	0	1	0	0	0
9)	29	41	I	49	73	NC	0	1	0	0	1
10	*	2A	42	J	4A	74	NC	0	1	0	1	0
11	+	2B	43	K	4B	75	NC	0	1	0	1	1
12	,	2C	44	L	4C	76	NC	0	1	1	0	0
13	-	2D	45	M	4D	77	NC	0	1	1	0	1
14	.	2E	46	N	4E	78	NC	0	1	1	1	0
15	/	2F	47	O	4F	79	NC	0	1	1	1	1
16	0	30	48	P	50	80	NC	1	0	0	0	0
17	1	31	49	Q	51	81	NC	1	0	0	0	1
18	2	32	50	R	52	82	NC	1	0	0	1	0
19	3	33	51	S	53	83	NC	1	0	0	1	1
20	4	34	52	T	54	84	NC	1	0	1	0	0
21	5	35	53	U	55	85	NC	1	0	1	0	1
22	6	36	54	V	56	86	NC	1	0	1	1	0
23	7	37	55	W	57	87	NC	1	0	1	1	1
24	8	38	56	X	58	88	NC	1	1	0	0	0
25	9	39	57	Y	59	89	NC	1	1	0	0	1
26	:	3A	58	Z	5A	90	NC	1	1	0	1	0
27	;	3B	59	[5B	91	NC	1	1	0	1	1
28	<	3C	60		5C	92	NC	1	1	1	0	0
29	=	3D	61]	5D	93	NC	1	1	1	0	1
30	>	3E	62		5E	94	NC	1	1	1	1	0

* Note

* Note:
Preset: DIP switch 1 to 5 : OFF
DIP switch 6 : ON

10.3.3 Operating functions and function commands

Various operations can be performed under the commands of the controller when the instrument is connected with the controller, using the GPIB.

Function commands are the commands which designate operations to be executed by the instrument from the controller using the GPIB.

A highly versatile automatic measuring system can be constituted by programming the operations in sequence at the controller.

Functions and function commands available through the GPIB are described below.

(1) Panel setting

To operate the instrument from the controller, set the instrument to the STORAGE MODE and the HOLD state by adjusting the STORAGE MODE switches on the front panel according to the following steps.

- ① Set one of the switches NORM, AVG, ENV, and ROLL to ON, while the NON STORE switch is set to OFF.
- ② Set the HOLD switch to ON.
- ③ Any of the switches PLOT, SINGLE, and SAVE CH1 is not activated. (The LED above the PLOT switch goes off.)

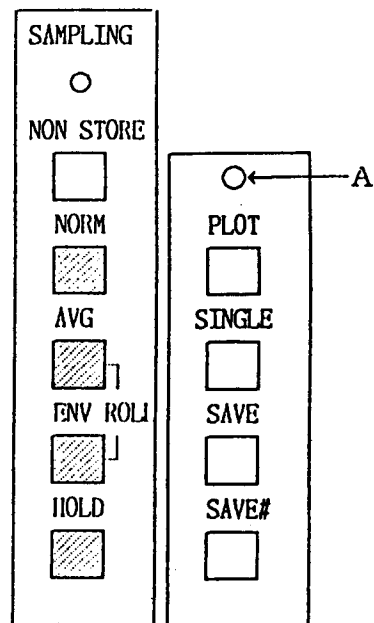

Be sure that the settings described above are completed before operating the GPIB.

(2) Operating functions

① Sampling start functions

The controller can start the following two sampling operations.

a) Normal single sampling

The single operation of the normal sampling is performed only once. When receiving this command, the instrument makes the normal sampling of the waveform data equivalent to the data of one whole picture. When all the data is prepared, the waveform on the CRT is updated and the instrument returns to the HOLD state.

b) Average single operation

Designated number of sweep is averaged once and the waveform on the CRT is updated to a new average waveform. Then the instrument returns to the HOLD state.

Also, the sampled waveform data acquired by the above procedure can be transferred to the controller using the waveform data transmitting function ③ .

② Sweep range setting function

Sweep range can be set when sampling a signal with the sampling start function ① .

When the HORIZONTAL MODE is set to A or ALT, the time range is set as the data of the A sweep range.

When the HORIZONTAL MODE is set to B, the time range is set as the data of the B sweep range.

After completion of the sweep range setting, the A sweep range must be greater than the B sweep range. When data out of this relationship is transmitted, the relationship of the sweep ranges are automatically corrected at the main unit side.

When the TIME/DIV value set by this function is being displayed, the newly set value is displayed instead.

When the TIME/DIV value is not displayed, the newly set value is not displayed. For example, when the STORAGE mode is set to ROLL, the range in the ROLL mode is displayed. In this case, when the Time range is set by using this function, the display on the CRT remains the same, and only the Time range of the Normal Single Sampling or the Average Single operation is newly set. When the sampling is executed by this function later, the display is updated and the TIME/DIV display is changed accordingly.

③ Waveform data transmission function

The instrument has the following four data memories:

- CH1 display memory which stores the CH1 waveform data
- CH2 display memory which stores the CH2 waveform data
- SAVE A memory
- SAVE B memory

Each memory has the capacity of loading 4000 data consisting of waveforms.

The waveform data can be transmitted to the listener from any of these memories.

The number of the data which is transferred at one time can be selected appropriately in the range of 1 to 4000. Either the decimal ASCII system or the binary system can be selected as the data transfer format.

The waveform data of each memory is 8 bits, i.e., 0 to 255 for the decimal system and $(00)_{16}$ to $(FF)_{16}$ for the hexadecimal system. These data ranges correspond to 10 vertical divisions of the CRT screen.

The data of the center horizontal graticule line is 128 ($(80)_{16}$ for the hexadecimal system). The data zero ($(00)_{16}$ for the hexadecimal system) corresponds to the position one division lower than the bottom graticule line. The data 255 ($(FF)_{16}$ for the hexadecimal system) is equal to the position one division higher than the top graticule line.

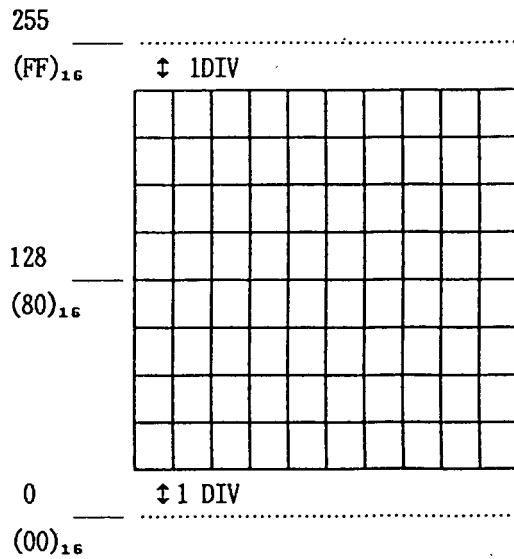

④ Transmission function of the measuring condition data

The instrument stores the data of the measuring conditions under which the data loaded in the four memories was sampled. By the command from the controller, the measuring condition of a waveform in a certain memory can be transmitted to the listener. Table 10-12 lists the format and the measuring condition data. Data is transmitted as a whole at a time of transfer. A specific data alone cannot be transmitted. The data format of the measuring conditions conforms to the ASCII system.

⑤ Reception function of the waveform data

The contents of the SAVE memory A and the SAVE memory B can be changed by the waveform data from the controller. Set the DISP SAVE switch to ON so that the rewritten data is displayed on the CRT.

⑥ Reception function of measuring condition data

The measuring condition data from the controller can be registered as the data for the waveform of the SAVE memory A or the SAVE memory B.

When the SAVE memory waveform is being displayed on the CRT with the DISP SAVE switch on, the display on VOLTS/DIV and TIME/DIV is changed accordingly when the data is registered.

⑦ Parameter calculation function

The following parameters can be calculated for any of the four memory waveform data.

- a) The maximum value
- b) The minimum value
- c) The mean value

⑧ Transimssion function of parameters

The calculated results of the above calculation can be transmitted to the listner.

⑨ Function of remote output to XY plotter

The function of the digital plot output to the XY plotter described in chapter 9 can be activated by the commands from the controller. To activate the function, the controller, the instrument and, the XY plotter must be connected via the GPIB cables.

For the specifications of usable plotters, refer to chapter 9.

This function can be activated regardless of the position of the D. PLOT switch on the rear of the instrument.

(3) Function command

The function command is the data which is transmitted by the controller while the ATN line goes High, and designates the execution of each function described in the preceding item (2) to the instrument.

Table 10-9 shows the function commands and formats.

Table 10-9 Function Commands (1/5)

No.	Function	Commands	Contents	Transmitting format																				
①	i) Sampling Norm single	S1 command	o Performs the single operation under the measuring condition which is previously set, and orders the command to retain the waveform data on the display memory.	<table border="1" style="margin-bottom: 10px;"> <tr> <td>S</td> <td>1</td> <td>DEL</td> </tr> </table> <table border="1"> <tr> <td>S</td> <td>2</td> <td>DEL</td> </tr> </table> <p>DEL indicates delimiter. Refer to Section 10.3.5.</p>	S	1	DEL	S	2	DEL														
	S	1	DEL																					
S	2	DEL																						
ii) Average single	S2 command	o Performs the average operation under the measuring condition which is previously set, and orders the command to retain the results on the display memory. • Refer to NOTE.																						
②	Sweep range setting function	TM command	o Designates the sweep range to do the above norm single or average single sampling. o When the horizontal mode is at A or ALT: A TIME/DIV is set. When the horizontal mode is B: B TIME/DIV is set.	<table border="1" style="margin-bottom: 10px;"> <tr> <td>T</td> <td>M</td> <td>(</td> <td>t</td> <td>t</td> <td>t</td> <td>t</td> <td>)</td> <td>DEL</td> </tr> </table> <p>tttt: Time range values (One of 0.1, 0.2, 0.5, 1.0, 2.0, 5.0, 10.0, 20.0, 50.0)</p> <p>uuuu: Unit (One of S, MS, MICS, NS)</p> <table border="1" style="margin-bottom: 10px;"> <tr> <td>T</td> <td>M</td> <td>(</td> <td>E</td> <td>X</td> <td>T</td> <td>C</td> <td>L</td> <td>K</td> <td>)</td> <td>DEL</td> </tr> </table> <p>External sampling clock operation can be assigned by transferring this command. (This command is valid only in the A mode.)</p>	T	M	(t	t	t	t)	DEL	T	M	(E	X	T	C	L	K)	DEL
T	M	(t	t	t	t)	DEL																
T	M	(E	X	T	C	L	K)	DEL														

Table 10-9 Function Commands (2/5)

No.	Function	Commands	Contents	Transmitting format																										
③	Waveform data transmission	Ri command	<ul style="list-style-type: none"> o Designates the transfer of the waveform data stored in the Memory i by the data number (nnnn) with the address data (mmmm) at the head. o Either the ASCII system or the binary system can be designated as the transmission method by X in the right column. o The controller designates the instrument to the talker after transmitting this command. Thus the desired data can be received. 	<div style="border: 1px solid black; padding: 5px; display: inline-block;"> <table border="1" style="border-collapse: collapse; text-align: center;"> <tr><td>R</td><td>i</td><td>(</td><td>m</td><td>m</td><td>m</td><td>m</td><td>,</td><td>n</td><td>n</td><td>n</td><td>n</td><td>,</td><td>x</td><td>)</td><td>DEL</td></tr> </table> </div> <p>"i" indicates the memory number.</p> <table border="1" style="border-collapse: collapse; text-align: center; margin: 10px 0;"> <tr><td>i</td><td>Memory</td></tr> <tr><td>1</td><td>CH1 display memory</td></tr> <tr><td>2</td><td>CH2 display memory</td></tr> <tr><td>3</td><td>SAVE memory A</td></tr> <tr><td>4</td><td>SAVE memory B</td></tr> </table> <p>"mmmm": Leading address in memories Four-digit integer: 0000 to 3999</p> <p>"nnnn": Number of transferred data Four-digit integer: 0001 to 4000</p> <p>x = A: ASCII system B: Binary system</p>	R	i	(m	m	m	m	,	n	n	n	n	,	x)	DEL	i	Memory	1	CH1 display memory	2	CH2 display memory	3	SAVE memory A	4	SAVE memory B
R	i	(m	m	m	m	,	n	n	n	n	,	x)	DEL															
i	Memory																													
1	CH1 display memory																													
2	CH2 display memory																													
3	SAVE memory A																													
4	SAVE memory B																													
④	Transmission of measuring condition data	R0 command	<ul style="list-style-type: none"> o Designates the transfer of the measuring condition data at the time of sampling the waveform that Memory i stores. o The controller designates the instrument to the talker after transmitting this command. Thus the desired data can be received. 	<div style="border: 1px solid black; padding: 5px; display: inline-block;"> <table border="1" style="border-collapse: collapse; text-align: center;"> <tr><td>R</td><td>0</td><td>(</td><td>i</td><td>)</td><td>DEL</td></tr> </table> </div> <p>"i" (= 1 to 4) indicates the same memory number as that of 3.</p>	R	0	(i)	DEL																				
R	0	(i)	DEL																									

Table 10-9 Function Commands (3/5)

No.	Function	Commands	Contents	Transmitting format						
⑤	Receiving of waveform data	Wi command	<ul style="list-style-type: none"> Transmits the waveform data from the controller to the instrument to designate the SAVE memory A or B to write the data in sequence beginning with the leading address mmmm. The ASCII system or the binary system can be designated as the transmission method by X in the right column. The controller designates the instrument to the listener after transmitting this command. Then the waveform data is transmitted. 	<p>W i (m m m m , n n n n , x) DEL</p> <p>"i" indicates the memory number. "i" must be 3 or 4.</p> <table border="1" data-bbox="478 649 588 798"> <tr><td>i</td><td>Memory</td></tr> <tr><td>3</td><td>Save memory A</td></tr> <tr><td>4</td><td>Save memory B</td></tr> </table> <p>"mmm": Leading address written in Four-digit integer: 0000 to 3999</p> <p>"nnnn": Number of transferred data Four-digit integer: 0001 to 4000</p> <p>x = A: ASCII system B: Binary system</p>	i	Memory	3	Save memory A	4	Save memory B
i	Memory									
3	Save memory A									
4	Save memory B									
⑥	Receiving of measuring condition data	W0 command	<ul style="list-style-type: none"> Transmits the measuring condition from the controller to the instrument, and designates the instrument to register the measuring condition data of the waveform that the SAVE memory A or B stores. The controller designates the instrument to the listener after transmitting this command, and transmits the measuring condition data. 	<p>W 0 (i) DEL</p> <p>"i" indicates the memory number, "i" must be 3 or 4.</p> <table border="1" data-bbox="635 1457 713 1606"> <tr><td>i</td><td>Memory</td></tr> <tr><td>3</td><td>Save memory A</td></tr> <tr><td>4</td><td>Save memory B</td></tr> </table>	i	Memory	3	Save memory A	4	Save memory B
i	Memory									
3	Save memory A									
4	Save memory B									

Table 10-9 Function Command (4/5)

No.	Function	Commands	Contents	Transmitting format																												
⑦ i) ii) iii)	Parameter calculation The maximum value The minimum value The mean value	E1 command E2 command E3 command	<ul style="list-style-type: none"> o Designates the calculation of the maximum value of the waveform data that the memory i stores. o Designates the calculation of the minimum value of the waveform data that the memory i stores. o Designates the calculation of the mean value of the waveform data that the memory i stores. Refer to NOTE. 	<table border="1" style="margin-bottom: 10px;"> <tr><td>E</td><td>1</td><td>(</td><td>i</td><td>)</td><td>DEL</td></tr> </table> <table border="1" style="margin-bottom: 10px;"> <tr><td>E</td><td>2</td><td>(</td><td>i</td><td>)</td><td>DEL</td></tr> </table> <table border="1"> <tr><td>E</td><td>3</td><td>(</td><td>i</td><td>)</td><td>DEL</td></tr> </table> <p>"i" indicates the memory number.</p> <table border="1" style="margin-left: 20px;"> <tr><td>i</td><td>Memory</td></tr> <tr><td>1</td><td>CH1 display memory</td></tr> <tr><td>2</td><td>CH2 display memory</td></tr> <tr><td>3</td><td>SAVE memory A</td></tr> <tr><td>4</td><td>SAVE memory B</td></tr> </table>	E	1	(i)	DEL	E	2	(i)	DEL	E	3	(i)	DEL	i	Memory	1	CH1 display memory	2	CH2 display memory	3	SAVE memory A	4	SAVE memory B
E	1	(i)	DEL																											
E	2	(i)	DEL																											
E	3	(i)	DEL																											
i	Memory																															
1	CH1 display memory																															
2	CH2 display memory																															
3	SAVE memory A																															
4	SAVE memory B																															
⑧ i) ii)	Trans- mitting function of parameter The Maximum value The minimum value	G1 command G2 command	<ul style="list-style-type: none"> o Designates the transmission of the maximum value calculated from the waveform data of Memory i. o Designates the transmission of the minimum value calculated from the waveform data of Memory i. 	<table border="1" style="margin-bottom: 10px;"> <tr><td>G</td><td>1</td><td>(</td><td>i</td><td>)</td><td>DEL</td></tr> </table> <table border="1"> <tr><td>G</td><td>2</td><td>(</td><td>i</td><td>)</td><td>DEL</td></tr> </table>	G	1	(i)	DEL	G	2	(i)	DEL																
G	1	(i)	DEL																											
G	2	(i)	DEL																											

Table 10-9 Function Commands (5/5)

No.	Function	Commands	Contents	Transmitting format						
iii)	The mean value	G3 command	<ul style="list-style-type: none"> o Designates the transmission of the mean value calculated from the waveform data of Memory i. o The waveform data must be calculated previously by the commands E1 to E3. o The controller designates the instrument to the talker after transmitting this command, and receives the prescribed data. 	<table border="1" style="margin-left: auto; margin-right: auto;"> <tr> <td>G</td> <td>3</td> <td>(</td> <td>i</td> <td>)</td> <td>DEL</td> </tr> </table> <p>"i" (=1 to 4) indicates the memory number as shown in item 7.</p>	G	3	(i)	DEL
G	3	(i)	DEL					
⑨	Remote output to XY plotter	PLOT command	<ul style="list-style-type: none"> o Outputs all the data displayed on the CRT of the instrument to the XY plotter for plotting the data. o When the controller designates the instrument to the talker and the XY plotter to the listener, the LED on the PLOT switch of the instrument lights and the data starts to be output to the plotter. o The end of the plot output processing is informed by the SRQ and the status bytes. Refer to NOTE. 	<table border="1" style="margin-left: auto; margin-right: auto;"> <tr> <td>P</td> <td>L</td> <td>O</td> <td>T</td> <td>DEL</td> </tr> </table>	P	L	O	T	DEL	
P	L	O	T	DEL						

NOTE: When the processing of a command is completed, the status bytes of the result of the processing are fed to the controller.

The controller checks if the SRQ exists on the bus, or detects the SRQ by interruption, and acquires the status bytes by the serial poll.

Thus, the controller judges that the processing is completed properly.

10.3.4 Format of transfer data

The arrangement format of data sent to and from the controller according to the function command described in the former chapter is shown below.

(1) Transmitting and receiving format of the waveform data

After receiving the Ri command (i=1 to 4) and being designated as the talker, the instrument transmits the waveform data according to the following format.

o ASCII system

#	i	@	,	m	m	m	m	,	n	n	n	n	,	D1	,	D2	,	D3	,			,	DN	,	S.C	DEL
---	---	---	---	---	---	---	---	---	---	---	---	---	---	----	---	----	---	----	---	--	--	---	----	---	-----	-----

o Binary system

#	i	@	,	m	m	m	m	,	n	n	n	n	,	D1	D2	D3								DN	S.C
---	---	---	---	---	---	---	---	---	---	---	---	---	---	----	----	----	--	--	--	--	--	--	--	----	-----

The comma (,) is a delimiter code.

In the binary system, D1 to DN and S.C are the binary data and the others are ASCII code data.

A delimiter code is not used among the data D1 to DN.

Only EOI is usable for DEL (delimiter), the EOI signal is transferred at the same time when the sum check data (S.C) transfer is transferred. In the receiving mode, the sum check can be omitted, since the sum check is not performed. (The sum check is neglected if it is added.) For details of each item, refer to Table 10-10.

(2) Transmitting and receiving format of measurement

When the instrument is designated as the talker after receiving the R0 command, the measuring condition data of the prescribed memory waveform is sent according to the following format. Also, when the instrument is designated as the listener after receiving the W0 command, it receives and registers the data sent according to the following format as the measuring condition data of the prescribed SAVE memory.

#	i	@	,	V.M	,	H.M	,	A.T	,	B.T	,	V.O	,	P.F	,	V.D	,	P.T	,	D.T	,	N.S	,	S.M	,	S.C	DEL
---	---	---	---	-----	---	-----	---	-----	---	-----	---	-----	---	-----	---	-----	---	-----	---	-----	---	-----	---	-----	---	-----	-----

"i" indicates the memory number which is the same as "i" of the commands R0(i) and W0(i).

In the receiving mode, the sum check can be omitted, since the sum check is not performed. (The sum check is neglected if it is added.)

(3) Transmitting format of parameters

When the instrument is designated as the talker after receiving the commands G1 to G3, the parameters of the waveform data of the prescribed memory is sent according to the following format.

o The maximum value

#	i	@	,	M	A	X	,	x	x	x	,	S.C	DEL
---	---	---	---	---	---	---	---	---	---	---	---	-----	-----

"i" is the memory number. The instrument transmits the parameters by adding the i data designated by the G1 (i) command.

xxx is the ASCII code data with the maximum value data of 3 digits in the decimal system.

o The minimum value

#	i	@	,	M	I	N	,	x	x	x	,	S.C	DEL
---	---	---	---	---	---	---	---	---	---	---	---	-----	-----

"i" is the memory number. The instrument transmits the parameters by adding the i data designated by the G2 (i) command.

xxx is the ASCII code data with the minimum value data of 3 digits in the decimal system.

o The mean value

#	i	@	,	A	V	R	,	x	x	x	,	S.C	DEL
---	---	---	---	---	---	---	---	---	---	---	---	-----	-----

"i" is the memory number. The instrument transmits the parameters by adding the i data designated by the G3 (i) command.

xxx is the ASCII code data with the mean value data of 3 digits in the decimal system. The sum check (S.C) and the delimiter (DEL) are the same as the transmission of the measuring condition data. Refer to Table 10-11.

Table 10-10 The format of the Transmission of the Waveform Data

No.	Item	Name	Format	ASCII system		Binary system	
				Data code	Bytes	Data code	Bytes
1	#i@	Memory number	"i" is 1, 2, 3 or 4 (NOTE 4)	ASCII	3	ASCII	3
2	mmmm	Leading address	Decimal, four digits 0000 to 3999	ASCII	4	ASCII	4
3	nnnn	Data number	Decimal, four digits 0001 to 4000	ASCII	4	ASCII	4
4	Di	Data	<ul style="list-style-type: none"> o ASCII system Decimal, three digits/1 data 000 to 255 o Binary system 8-bit binary data 	ASCII	3	Binary	1
5	S.C	Sum check (NOTE 1) (NOTE 2)	<ul style="list-style-type: none"> o ASCII system Hexadecimal ASCII data 00 to FF o Binary system 8-bit binary data 	ASCII	2	Binary	1
6	DEL	Delimiter	1. C/R L/F 2. C/R EOI 3. EOI One of the above three kinds (NOTE 3) EOI only available for the binary system	ASCII	0 to 2 (variable)	---	0

NOTE 1: The Sum Check data adds all the former data (including symbols like a comma, etc.) by the binary system, and uses the least significant 8 bits of the data obtained as a result.

NOTE 2: In the receiving mode, the sum check can be omitted.

NOTE 3: Use the same delimiter as one which comes with the function command from the controller.

NOTE 4: In the receiving mode, only 3 or 4 can be designated.

Table 10-11 Transmitting and receiving format of measuring condition data (1/2)

No.	Item	Name	Format	Byte number (NOTE 3)	
				Transmitting	Receiving
1	#i@	Memory number	"i" is 1, 2, 3 or 4 (NOTE 4)	3	3
2	V.M	Vertical mode	One of CH1, CH2, CHOP (including dual trace mode), ADD (Right justify)	4	4
3	H.M	Horizontal mode	A (including ALT mode) or B	1	1
4	A.T	A TIME/DIV	<ul style="list-style-type: none"> • Normal operation F3.1 (NOTE 1) Unit: S, MS, MICS or NS (Right justify) • External sampling clock operation A TIME range value: "EXTACLK" (NOTE 5) 	9	9
5	B.T	B TIME/DIV	B TIME range value: F3.1 (NOTE 1) Unit: S, MS or MICS (Right justify)	9	9
6	V.C	Volt CAL	CAL or UNCAL (Right justify)	5	5
7	P.F	Probe factor	P1X or P10X (Right justify)	4	4
8	V.D	Volt/DIV	VOLT range value: F3.1 (NOTE 1) Unit: V, MV (Right justify)(NOTE 2)	7	7
9	P.T	Pretrigger	0.0 to 9.9 DIV: F2.1 (NOTE 1)	7	7
10	D.T	Delay amount	0.20 to 10.00 (NOTE 1) DIV: F4.2	9	9
11	N.S	No. of sweeps	2, 4, 8, 16, 32, 64, 128 or 256	3	3
12	S.M	Storage mode	NOR (normal), ROL, AVG or ENV	3	3

Table 10-11 Transmitting and receiving format
of measuring condition data (2/2)

No.	Item	Name	Format	Byte number (NOTE 3)	
				Transmitting	Receiving
13	S.C	Sum check	Hexadecimal ASCII data 00 to FF	2	--
14	DEL	Delimiter	1. C/R L/F 2. C/R EOI 3. EOI Use one of the above three as the delimiter of the function command transmitted from the controller.	0 to 2 (variable)	0 to 2 (variable)

NOTE 1: For example, F3.1 is indicated as 50.0.

A space symbol of over one word is placed between the value and the unit.

NOTE 2: When the VOLTS/DIV settings of CH1 and CH2 are different in the ADD mode, the data is transmitted with ADD only.

NOTE 3: "Transmitting" and "Receiving" are described, viewed from the instrument.

NOTE 4: In the receiving mode, only 3 or 4 can be designated.

NOTE 5: "EXT ΔCLK" is transferred or received only when the HORIZONTAL switch is at A. Δ indicates blank.

NOTE : For the sampling rate at each time range, see Fig. 8-3.

10.3.5 Delimiter

For the transmission of the waveform data or the function command message, the controller sends a delimiter to indicate the end of data to the instrument.

The instrument has three kinds of delimiters so that it can be used with any equipment. The instrument sends back the same delimiter as one used at the end of a function command message to the controller.

However, if the controller is not provided with the following delimiters, it is necessary to send some delimiter (usually HEX data).

- 1) "C/R", "L/R"
- 2) "C/R", "EOI"
- 3) "EOI" X

10.3.6 Processing of abnormal operation

The instrument sends the byte in order to respond to a message command, or to inform the controller of the status. The following is the format and the meaning of these status bytes.

(1) Status byte

27	26	25	24	23	22	21	20
0	SRQ	ERR	BUSY				

1. SRQ = 1 : Indicates that the SRQ is being transmitted.
2. ERR = 1 : Indicates that the received data is in error status.
3. BUSY= 1 : Indicates that the instrument is occupied.
4. The values listed in the table under the following paragraph are given to the bits $2^3 - 2^0$ to let each status byte to have its own meaning.

(2) Contents of status bytes

Each status byte has following meanings.

No.	Status byte	Description
1	41	Processing for a command is completed normally.
2	51	Indicates that the instrument is busy.
3	61	Command error
4	63	Data content error
5	64	Excessive data number
6	65	Insufficient data number
7	67	Protocol error

10.4 Protocol

10.4.1 Switching of the command mode and the data mode

Fig. 10-4 shows the relationship between the ATN signal and the commands. In the command mode, the ATN signal is L and delivered in a lump, ahead of the data mode. The data mode ends when the ATN signal is H and the delimiter appears. As a rule, the command mode should not be interrupted during the data mode.

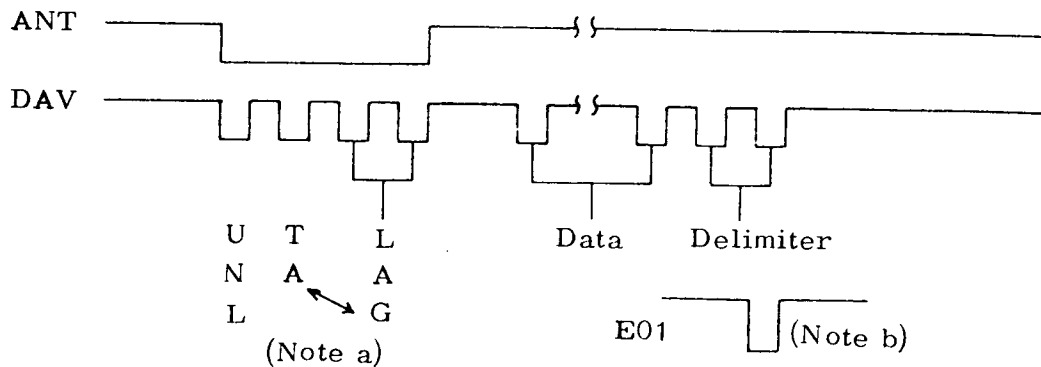

Fig. 10-4 Command mode and data mode

NOTES:

- Order of the talker address (TA) and the listener address group (LAG) may be at random.
- EOI is output at the same time with the final data byte including a delimiter.

10.4.2 Address command

Fig. 10-5 shows the protocol of SDC.

TA may be replaced with LAG as shown below.

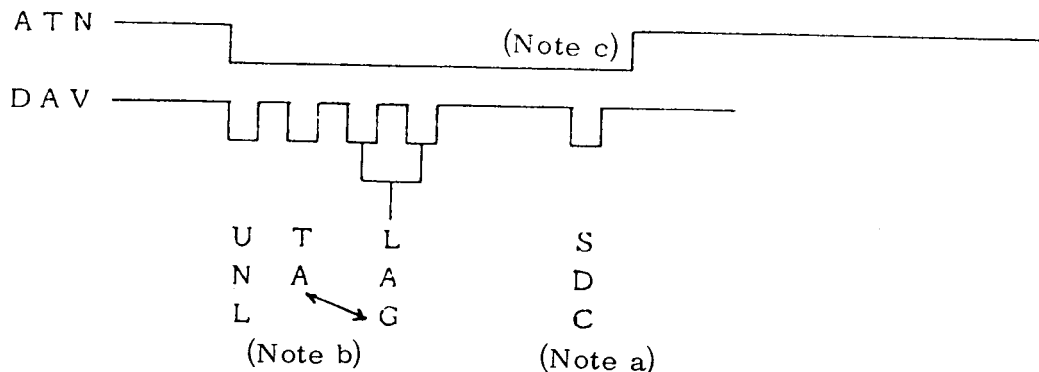

Fig. 10-5 Address command

NOTES:

- a) The illustrated SDC only is used for the instrument, while others such as GTL, GET, and TCT are not used in this case.
- b) The order of TA to LAG may be at random.
- c) The ATN level requires to be returned to "High" by some means (addition of another command, etc.).

10.4.3 Universal command

Fig. 10-6 shows protocol of the universal command.

NOTES:

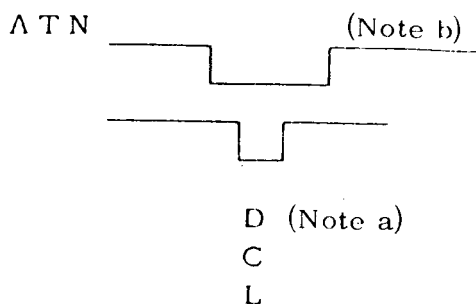

- a) The illustrated DCL is only used for the instrument while LLO is not used in this case.
- b) ATN level requires to be returned to "High" by some means (addition of another command).

Fig. 10-6 Universal command

10.4.4 Serial poll

Fig. 10-7 shows three protocols of serial poll.

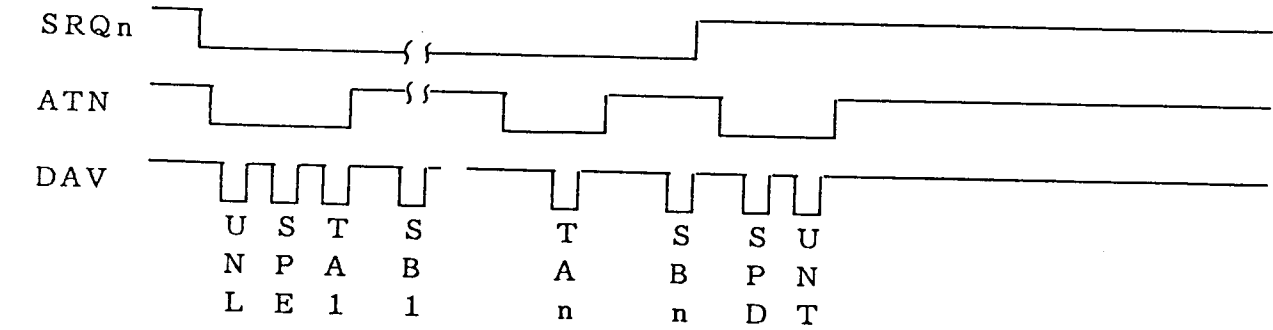

(a) Method most faithful to the IEEE-488 (1975) standards to read status bytes serially.

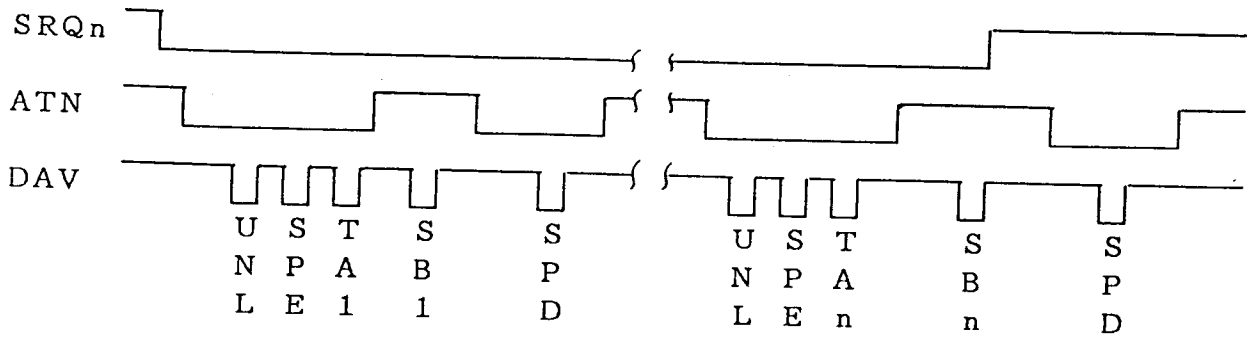

(b) Method to read status bytes one by one (UNT is not inserted after SPD.)

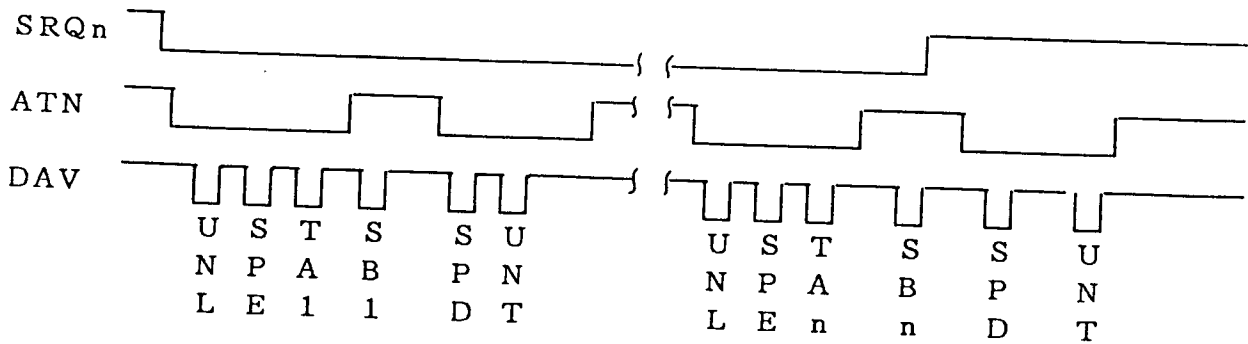

(c) Method to read status bytes one by one (UNT is inserted after SPD.)

Fig. 10-7 Protocol of serial poll

10.4.5 Precaution for protocols

- ① When the ATN goes L, the equipment responds to ATN as high priority.
Therefore, the processing is halted if the ATN goes "L" during data transmission or in reception.
- ② When the TA or LAG command is designed in the same address, the last command (TA or LAG) will be accepted.
- ③ Address command may be repeated.
The LAG and COMi address commands are repeated after LAG as follows, and only the related LAG is processed. That is, COM1 and COM2 are accepted by LAG1 while COM3 and COM4 are accepted by LAG2.
ATN="L" LAG1, COM1, COM2, LAG2, COM3, COM4, ATN="H"
- ④ Universal and address commands may exist at the same time. However, the TA command (or LAG command) must be used when changing the universal command to the address command.
- ⑤ Other protocols conform to IEEE-488(1975/78) standards.

10.5 Caution on the Data Transfer Sequence

The status bytes of the error status are transmitted when there is a format error in the message command.

10.6 Connection and Operation of the Digital Storage Oscilloscope and the GPIB

- ① Connect the GPIB cable between the instrument and the controller (GPIB system).
- ② Set the instrument address independent of the other devices. (See Item 10.3.2.)
- ③ Set the instrument power to on, and set the front panel controls for proper signal measurement. Reprass the HOLD mode function switch. Now, the data transfer is possible. Perform the operation according to the commands from the controller.

10.7 Programming for Data Transfer

Programming of input/output data for the GPIB is classified into two methods. One is the method employing the macro instruction from the controller itself such as "PRINT", "INPUT", etc. The other is the method employing the command directly controlling the GPIB such as "PEEK", "POKE", etc.

* Macro instruction:

Although the method employing the macro instruction simplifies the programming, the sequence by the macro control of the GPIB may not adapt to sequence of the GPIB of the instrument.

* Direct command:

Although the programming is complicated by this method, data transfer between the instrument and the controller is always available.

When the computer is provided with an assembly language only, this is the only method.

To facilitate programming, first execute a simple test program, send the function command to the instrument by the simple program, and check the resultant data received from the instrument. This simple test program will check the system validation and then a complete program can be written.

The following program statement depends on the employed controller; transmitting method of multiline interface message command, function command, receiving method of the data, etc. Before transmission, read thoroughly the employed controller manual, because controllers may require preparation such as data buffer area reservation and delimiter setting.

Items 10.7.1 through 10.7.3 describe the basic methods of producing program.

10.7.1 GPIB - Digital Storage Oscilloscope CONTROL PROGRAMMING 1 (Panel information and waveform data transfer)

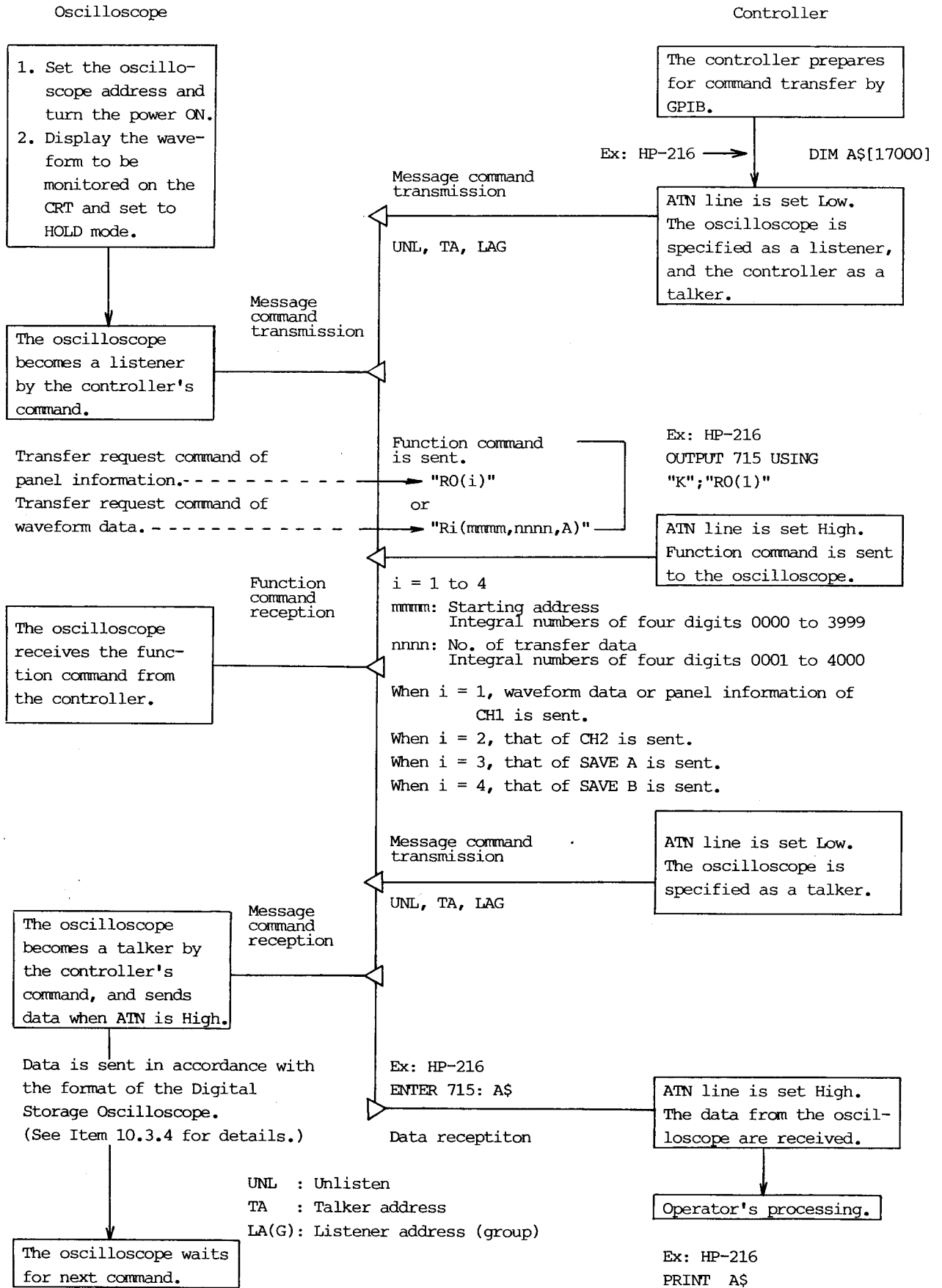

10.7.2 GPIB - Digital Storage Oscilloscope CONTROL PROGRAMMING 2
 (Indication of normal sample starting to the Digital Storage Oscilloscope and serial poll)

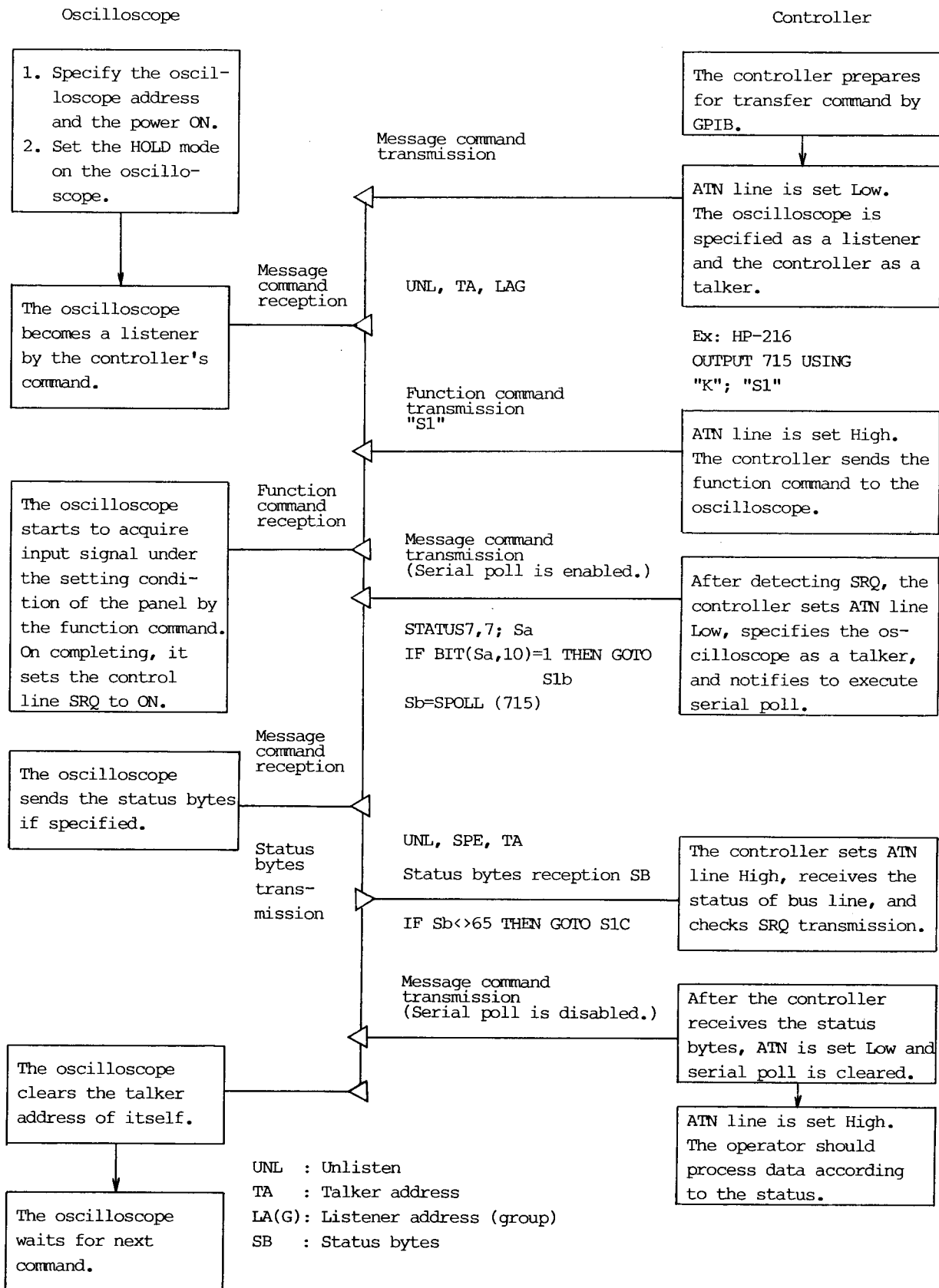

10.7.3 GPIB - Digital Storage Oscilloscope CONTROL PROGRAMMING 3

Flowchart for data transfer to the Digital Storage Oscilloscope
(The controller program)

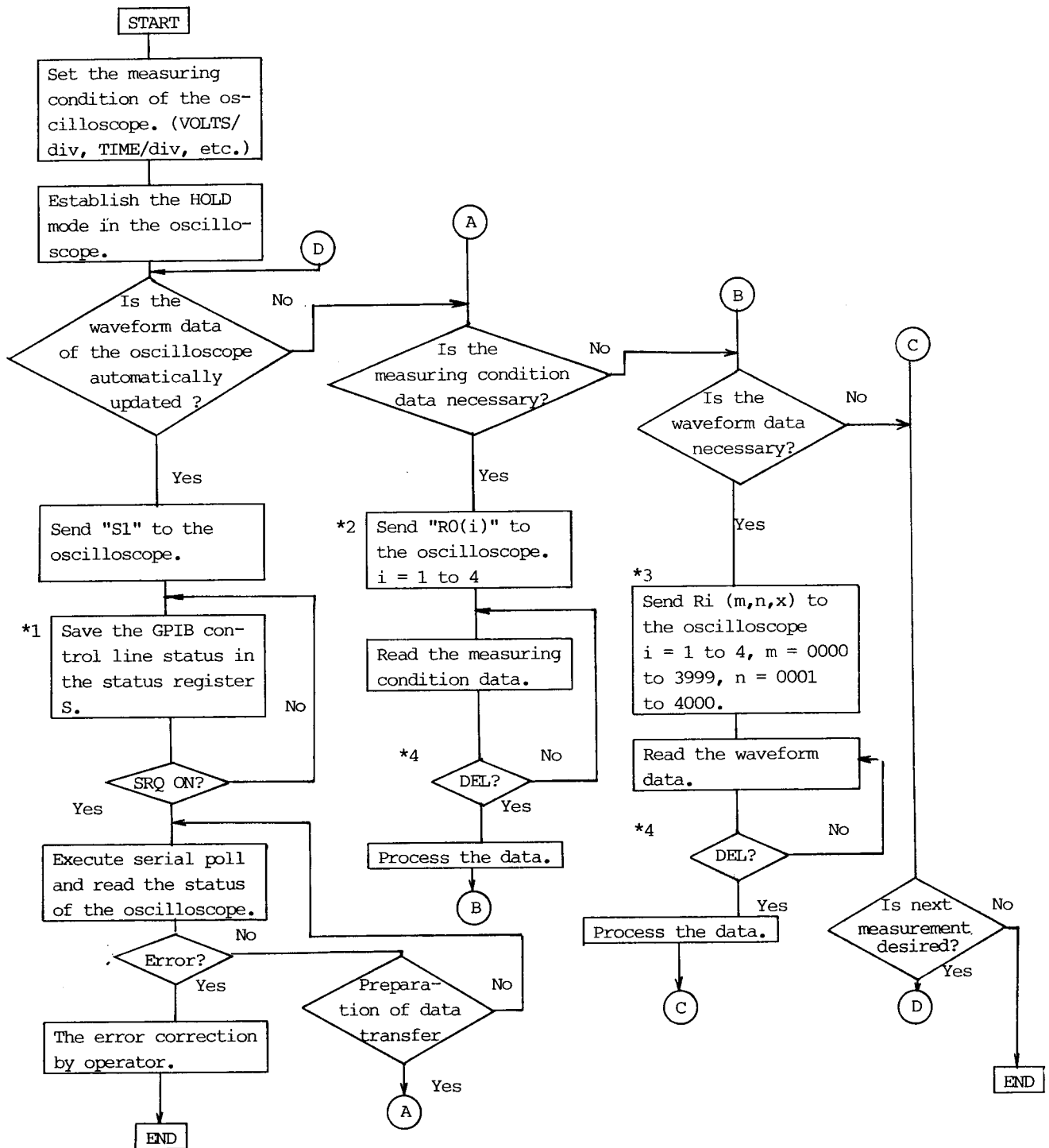

*1 S is determined by the computer used.

*2 i = Integer 1 to 4 1: CH1 2: CH2 3: SAVE memory of A 4: SAVE memory of B

*3 i = Same as *2. m = Integers of four digits 0000 to 3999 for starting address of the memory
n = Integers of four digits 0001 to 4000 for number of transferred data
x = A: ASCII system B: Binary system

*4 DEL is a delimiter. One of CR LF, CR EOI, or EOI is sent back in accordance with the DEL sent from the controller.

10.8 Major Causes of Abnormal Data Transfer

- (1) A cable is not connected or power of any equipment in the system is not turned on. (See NOTE.)
- (2) The instrument is not in the HOLD mode. Verify that the panel setting are as specified in 10.3.3 (1).
- (3) The trigger mode is in the NORM trigger mode, and the trigger signal is not connected. (When the single sweep is executed by the S1 and S2 commands from the controller.)
- (4) The function command does not correspond to that of the instrument.
- (5) The address setting of the instrument does not correspond to the address specified by the controller. The same address is used by other units.
- (6) The format of delimiter does not correspond to that of the instrument. The same delimiter is not used for transmission and reception of data. (For example, C/R and EOI delimiters are used for transmission but C/R and L/F is used at reception.)
- (7) The instrument is not initialized after the address change. When the instrument is turned on, the instrument reads the address switch settings and memorizes the data. Consequently, the instrument address can not be changed while the power is on.
- (8) The function with which the instrument is not provided is executed. (PPC, GET, TCT, etc.)
- (9) The buffer area of the data is not provided.
(Transmission of a large amount of data is requested for the instrument though a listener has a small amount of buffer area.)
- (10) At serial polling, the address of the status register for detecting the SRQ of the control line is not assigned properly.
- (11) There is an error in program. Use of decimal and hexadecimal systems is not proper.

NOTE:

When the instrument is not turned on, it does not operate. Otherwise, when plural units are connected and the power of units not used is off, the noise margin of the bus line is lowered. This may result in an improper operation. It is recommended to disconnect or turn on the units not in use.

Check the above items when data transfer is not executed properly.

10.9 Programming Example

The following is an example of the programs in the configuration of the instrument and HP85.

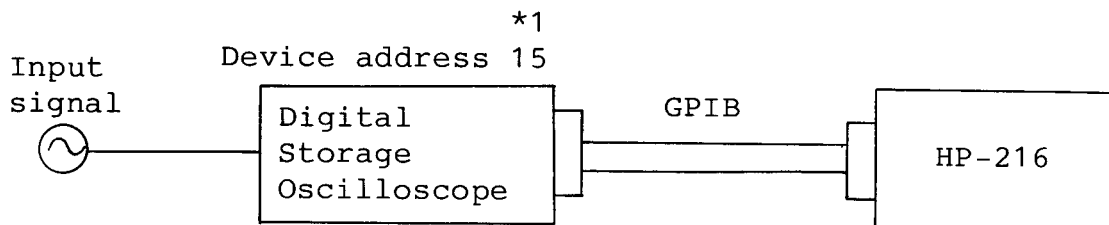

(*1) The ADDRESS switch on the rear of the instrument is set to 1 at factory. Note that the description of this section is made with the ADDRESS switch set to 15. Refer to 10.3.2 setting of the ADDRESS switch.

10.9.1 Program example 1 "S1" command

The normal single operation is activated by the "S1" command. This is a program for observing the operation until the sampling is completed.

Program example 1

```
10  REM***S1 COMMAND***           — Comment
20  Sa=0
30  Sb=0
40  OUTPUT 715 USING "k";"S1"     — Transmission of S1 command
50  Sla: STATUS 7, 7; Sa          —
60  IF BIT(Sa,10)=1 THEN GOTO Slb } Observation of SRQ line
70  GOTO Sla                      }
80  Slb: Sb=SPOLL(715)           — Executiton of serial poll
90  IF Sb<>65 THEN GOTO Slc       — Check of status bytes
100 REM *****
110 REM **ANOTHER PROGRAM**     — Single sweep is completed.
120 REM *****                 Other programs can be executed.
130 GOTO S1d
140 Slc: DISP "ERROR STATUS=";Sb — If the status byte is abnormal,
150 Sld: END                      status bytes are displayed and
                                operation is completed.
                                (Error process)
```

(Explanation) The instrument activates the sampling by "S1". When the sampling is completed, the SRQ signal is generated and the status bytes are displayed to indicate that the operation is completed satisfactory. The lines from 50 to 70 observe the SRQ signal. The lines from 80 to 90 execute a serial poll and checks the status bytes. If the status bytes are 65 (41 for hexadecimal), the operation is completed with a satisfactory result and it is possible to proceed another program (e.g., a program to read a waveform data).

10.9.2 Program example 2 "S2" command

The single operation of the average mode is activated by the "S2" command. This is a program for observing the operation until the sampling is completed.

Program example 2

```
10  REM *** S2 COMMAND ***
20  Sc=0
30  Sd=0
40  OUTPUT 715 USING "K"; "S2"           — Transmission of S2 command
50 S2a: STATUS 7,7;Sc                    — Observation of SRQ line
60  IF BIT(Sc,10)=1 THEN GOTO S2b       —
70  GOTO S2a                             — Execution of serial poll
80 S2b:  Sd=SPOLL(715)                   — Check of status bytes
90  IF Sd<>65 THEN GOTO S2c
100 REM *****
110 REM ** ANOTHER PROGRAM **           — Single operation in average mode is
120 REM *****                          completed. Other programs can be
130 GOTO S2d                               executed.
140 S2c: DISP "ERROR STATUS=";Sd         — If status bytes are abnormal,
150 S2d: END                               status bytes are displayed and
                                           operation is completed.
```

10.9.3 Program example 3 "TM" command

This is a program for setting the time range to 5 ms/DIV by the "TM" command.

With this program, it is possible to know that the setting is completed normally (just like the program example 1).

Program example 3

```
10  REM *** TM COMMAND ***
20  T1=0
30  T2=0
40  OUTPUT 715 USING "K";"TM(5.0 MS)"   — Transmission of TM command
50 Tma:STATUS 7,7;T1                    — Observation of SRQ line
60  IF BIT(T1,10)=1 THEN GOTO Tmb       —
70  GOTO Tma                             — Execution of serial poll
80 Tmb:  T2=SPOLL(715)                   — Check of status bytes
90  IF T2<>65 THEN GOTO Err
100 REM *****
110 REM ** ANOTHER PROGRAM ****        — Time range is set and other
120 REM *****                          programs can be executed.
130 GOTO Eee
140 Err: DISP "ERROR STATUS=";T2         — If status bytes are abnormal,
150 Eee: END                               status bytes are displayed and
                                           operation is completed.
```

10.9.4 Program example 4 "Ri" command

This is a program to receive 50 words of the CH1 waveform data from the 0 address by the "Ri" command.

Program example 4 (a): ASCII code transfer

Program example 4 (b): Binary code transfer

Program example 4 (a)

```
10 REM *** R1 (mmmm,nnnn,x) COMMAND ***
20 DIM K$ [17000]
30 OUTPUT 715 USING"K";"R1 (0000,0050,A)" — Transmission of Ri command
40 ENTER 715;K$ — Reception of waveform data
50 PRINT K$ — Display
60 END
```

Program example 4 (b)

```
10 REM *** Ri (mmmm,nnnn,x) COMMAND ***
20 DIM K$[5000],P$[17000]
30 OUTPUT 715 USING"#,K";"R1(0000,0050,B)",END — Transmission of Ri command
                                         (Delimiter EOI)
40 ENTER 715 USING "-K";K$ — Reception of waveform data
                                         (Delimiter EOI)
50 FOR I=1 TO 50
60 P$=P$&VAL$(NUM(K$[I+14, I+14]))& ", " ] Converts binary data into
70 NEXT I ] Letter codes (ASCII)
80 PRINT K$[1,14] — Display
90 PRINT P$
100 END
```

10.9.5 Program example 5 "R0" command

This is a program to receive the measuring condition data of CH1 by the "R0" command and display the data.

Program example 5

```
10 REM *** R0 (i) COMMAND ***
20 DIM R$[100]
30 OUTPUT 715 USING "K"; "R0 (1)" — Transmission of R0(i) command
40 ENTER 715;R$ — Reception of measuring condition data
                                         of CH1
50 PRINT R$ — Display
60 END
```

10.9.6 Program example 6 "Wi" command

This is a program to write data in the save memory A by the "Wi" command. The lines 30 to 170 set the waveform data to be transmitted to the instrument to the letter variable A\$. Set the waveform data according to application. "Wi" command is transmitted by the lines 180 and 190, and the waveform data set to A\$ is written in the save memory A. The waveform data from the 0 address to the 2047 address is written in the save memory A as shown in Fig. 10-8.

Program example 6 (a): ASCII code transfer

Program example 6 (b): Binary code transfer

Program example 6 (a)

```
10 REM***Wi (mmmm,nnnn,x) COMMAND***
20 DIM A$[17000],B$[10]
30 FOR I=1 TO 4
40 FOR B=0 TO 255
50 IF B>=100 THEN B$=VAL$(B)
60 IF B<100 THEN B$="0"&VAL$(B)
70 IF B<10 THEN B$="00"&VAL$(B)
80 A$=A$&B$&","
90 NEXT B
100 FOR B=0 TO 255
110 C=255-B
120 IF C>=100 THEN B$=VAL$(C)
130 IF C<100 THEN B$="0"&VAL$(C)
140 IF C<10 THEN B$="00"&VAL$(C)
150 A$=A$&B$&","
160 NEXT B
170 NEXT I
180 OUTPUT 715 USING "K";"w3(0000,2048,A)"
190 OUTPUT 715 USING "K";A$
200 END
```

Set waveform data to letter variable A\$.
Set a triangle waveform (000-255, 255-000) shown in Fig. 10.8 to 2048 words by ASCII code.

— Transmission of Wi command
— Transmission of waveform data

Fig. 10-8

Program example 6 (b)

```

10  REM***Wi(mmmm,nnnn,x) COMMAND***
20  DIM A$[17000],B$[10]
25  A$="#3@,0000,2048,"
30  FOR I=1 TO 4
40  FOR B=0 TO 255
50  B$=CHR$(B)
60  A$=A$&B$
70  NEXT B
80  FOR B=0 TO 255
90  C=255-B
100 B$=CHR$(C)
110 A$=A$&B$
120 NEXT B
130 NEST I
140 OUTPUT 715 USING"#,K";"W3(0000,2048,B)",END
150 OUTPUT 715 USING"#,K";A$,END
160 END

```

|
 | Set waveform data to
 | letter variable A\$.
 | (Set the triangle waveform
 | shown in Fig. 10-8.)
 |
 | Transmission of
 | Wi command
 | Transmission of
 | waveform data

10.9.7 Program example 7 "W0" command

This is a program to register the measuring condition data in the save memory A by the "W0" command.

Program example 7

```

10  REM***W0(i)COMMAND***
20  DIM F$[200]
30  F0$="#3@,"
40  F1$="CHOP,"
50  F2$="A,"
60  F3$=" 50.5 MS,"
70  F4$=" 20.0 MS,"
80  F5$=" CAL,"
90  F6$="P10X,"
100 F7$="50.0 MV,"
110 F8$="5.0 DIV,"
120 F9$="10.00 DIV,"
130 Fa$=" 2,"
140 Fb$="NOR,"
150 F$=F0$&F1$&F2$&F3$&F4$&F5$&F6$&F7$&F8$&F9$&Fa$&Fb$
160 OUTPUT 715 USING "K";W0(3)"
170 OUTPUT 715 USING "K";F$
180 END

```

|
 | Set measuring
 | condition data
 | to register to
 | letter variable
 | F\$.
 |
 | Transmission of W0(i)
 | Transmission of measuring
 | condition data

10.9.8 Program example 8 "E1", "E2", "E3", "G1", "G2", and "G3" commands

Program 8 (a) shows a process from the calculation of the maximum value to the reception and display of the maximum data.

The "E1" command is calculated by the line 50 and the calculation of the maximum value of CH1 is designated. The lines 60 to 100 are for the observation of the SRQ line and the check of the status bytes, and display that the calculation of the maximum value is completely normally. The lines 110 and 120 input the maximum data by the "G1" command.

Program example 8 (a)

10	REM***E1(i)G1(i)COMMAND***	
20	Ea=0	
30	Eb=0	
40	DIM G\$[100]	
50	OUTPUT 715 USING "K";"E1(1)"	— Transmission of E1(i) command
60E1a:	STATUS 7,7;Ea] Observation of SRQ line
70	IF BIT (Ea,10)=1 THEN GOTO E1b	
80	GOTO E1a	
90E1b:	Eb=SPOLL(715)	— Execution of serial poll
100	IF Eb<>65 THEN GOTO E1c	— Check of status bytes
110	OUTPUT 715 USING "K";"G1(1)"	— Transmission of G1(i) command
120	ENTER 715;G\$	— Reception of maximum value
130	DISP G\$	— Display
140	GOTO E1d	
150E1c:	DISP "ERROR STATUS=";Eb	— If the status bytes are abnormal,
160E1d:	END	the status bytes are displayed and operation is completed.

Program 8 (b) shows a process from the calculation of the minimum value to the reception and display of the minimum data.

Program 8 (c) shows a process from the calculation of the mean value to the reception and display of the mean data.

The contents of the programs are the same as that of program example 8 (a).

Program example 8 (b)

```

10  REM***E2(i),G2(i) COMMAND***
20  Ec=0
30  Ed=0
40  DIM H$(100)
50  OUTPUT 715 USING "K";"E2(1)"      — Transmission of E2(i) command
60E2a:  STATUS 7,7;Ec                — Observation of SRQ line
70  IF BIT (Ec,10)=1 THEN GOTO E2b
80  GOTO E2a
90E2b:  Ed=SPOLL (715)                — Execution of serial poll
100     IF Ed<>65 THEN GOTO E2c        — Check of status bytes
110     OUTPUT 715 USING "K";"G2(1)"  — Transmission of G2 (i) command
120     ENTER 715;H$                  — Reception of minimum value
130     DISP H$                       — Display
140     GOTO E2d
150E2c:  DISP "ERROR STATUS=";Ed      — If the status bytes are abnormal,
160E2d:  END                          the status bytes are displayed and
                                         operation is completed.

```

Program example 8 (c)

```

10  REM***E3(i)G3(i)COMMAND***
20  Ee=0
30  Ef=0
40  DIM I$(100)
50  OUTPUT 715 USING "K";"E3(1)"      — Transmission of E3(i) command
60E3a:  STATUS 7,7;Ee                — Observation of SRQ line
70  IF BIT (Ee,10)=1 THEN GOTO E3b
80  GOTO E3a
90E3b:  Ef=SPOLL(715)                — Execution of serial poll
100     IF Ef<>65 THEN GOTO E3c        — Check of status bytes
110     OUTPUT 715 USING "K";"G3(1)"  — Transmission of G3(i) command
120     ENTER 715;I$                  — Reception of mean value
130     DISP I$                       — Display
140     GOTO E3d
150E3c:  DISP "ERROR STATUS=";Ef      — If the status bytes are abnormal,
160E3d:  END                          the status bytes are displayed and
                                         operation is completed.

```

10.9.9 Program example 9 "PLOT" command

This is a program to activate the plot output to the XY plotter by the PLOT command.

In this program, the GPIB address switch on the XY plotter is set to 5.

The line 40 outputs the PLOT command.

Designate the instrument to a talker and the XY plotter to a listener on the line 50. Then the instrument executes the plot output to the XY plotter. When the plot output is completed, the instrument generates the SRQ signal and the status bytes indicate that the operation is completed normally.

The lines from 70 to 90 observe the SRQ signal.

The lines 100 and 110 execute a serial poll and check the status bytes. If the status bytes are 65, the plot output is completed normally, and it is possible to proceed the other programs.

Program example 9

```
10  REM***PLOT COMMAND***           — Comment
20  Pa=0
30  Pb=0
40  OUTPUT 715 USING "K";"PLOT"     — Transmission of PLOT command
50  SEND 7;CMD UNL TALK 15 LISTEN 5 — Designate Digital Storage
                                       Oscilloscope (address 15)
                                       to talker and the XY plotter
                                       (address 5) to listner.

60  SEND 7; DATA
70  P1a:  STATUS 7,7;Pa
80  IF BIT(Pa,10)=1 THEN GOTO P1b   — Observation of SRQ line
90  GOTO P1a
100 P1b:  Pb=SPOLL (715)             — Execution of serial poll
110     IF Pb<>65 THEN GOTO P1c      — Check of status bytes
120     REM*****
130     REM**ANOTHER PROGRAM**
140     REM*****
150  GOTO P1d
160 P1c  DISP "ERROR STATUS=";Pb     — If status bytes are abnormal,
170 P1d:  END                       the status bytes are displayed
                                       and operation is completed.
```

11. OPTION

11.1 IC Memory Card Reader/writer

Use the following IC memory card reader/writer when reading or writing the contents of the IC memory card by a personal computer.

Name: IC memory card reader/writer

Type: IU-1

Interface with a personal computer: Conforms to RS232C

Applicable cable: RS232C cable or No.4286IC card or normal type RS232C cable.

11.2 Extension Interface

This is the interface to be connected to the instrument by using the extension slot of a personal computer.

with this interface, it is possible to configure the system which uses the instrument as a high speed data acquisition component.

12. SPECIFICATIONS

The following specifications are applicable to the VC-6275, VC-6175, and VC-6075 oscilloscopes unless otherwise noted.

o CRT

Graticule: 6-inch, with internal graticule
0%, 10%, 90% and 100% markers
8 x 10 DIV (1 DIV = 1cm)

Phosphor: P31

Accelerating potential: 17 kV approx.

External intensity modulation: Coupling: DC coupling
Voltage: 5 V or more
Maximum input voltage: 30 V (DC+AC peak) or 30 V_{p-p} AC at 1 kHz or less
Bandwidth: DC to 5 MHz

o VERTICAL DEFLECTION SYSTEM

Sensitivity: 2 mV/DIV to 5 V/DIV $\pm 3\%$
(switchable in 11 steps)
Continuously variable

Bandwidth: DC to 100 MHz -3dB
2 mV/DIV : DC to 20 MHz -3dB
AC low pass : 10 Hz

Rise time: 3.5 ns approx.
2 mV/DIV : 17.5 ns approx.

Delay time: Leading edge can be monitored

Maximum input voltage: 400 V (DC+AC peak) at 1 kHz or less

Input coupling: AC, DC, GND

Input impedance: 1 M Ω $\pm 1.5\%$, 23pF ± 3 pF

Display modes: CH1, CH2, DUAL, CHOP(250 kHz approx.),
ADD (DIFF mode can be established when the CH2 is in the INVERT mode.)

Bandwidth limiting function:	20 MHz (only valid for a trigger signal in the STORAGE mode)
Polarity selection	+, - (CH2 only)
Common-mode rejection ratio:	20 dB minimum at 20 MHz
X-Y operation:	NON STORE mode: X-axis, Y-axis selectable STORAGE mode: X-axis = CH1 Y-axis = CH2
Sensitivity:	X axis: CH1, CH2: 2 mV to 5 V/DIV $\pm 3\%$ EXT: 0.1 V/DIV $\pm 5\%$ EXT $\div 10$: 1 V/DIV $\pm 5\%$ Y axis: 2 mV to 5 V/DIV $\pm 3\%$
Phase error:	3 $^{\circ}$ or less from DC to 50 kHz
X bandwidth:	DC to 500 kHz (-3 dB)

o HORIZONTAL DEFLECTION SYSTEM

Sweep time	
* NON STORE mode	
A(main) sweep:	50 ns/DIV to 0.5 s/DIV Continuously variable (UNCAL)
B(delay) sweep	50 ns/DIV to 50 ms/DIV
* STORAGE mode	
A(main) sweep:	50 ns/DIV to 0.5 s/DIV 50 ns/DIV to 1 μ s/DIV available only for a repetitive waveform
B(delay) sweep:	2 μ s/DIV to 50 ms/DIV
* ROLL mode:	0.1 s/DIV to 50 s/DIV
* ENV mode	
A(main) sweep:	0.1 ms/DIV to 0.5 s/DIV
B(delay) sweep:	0.1 ms/DIV to 50 ms/DIV
Accuracy:	X1: $\pm 3\%$, X10 MAG: $\pm 4\%$
Holdoff time:	Variable
Delay time:	1 μ s to 5s
Delay jitter:	1/20,000 or less

Sweep magnification: X10
 Maximum sweep rate: 5 ns/DIV
 Alternate separation: Variable (NON STORE only)
 Trigger lock function: Provided
 Auto range function: Provided
 External clock sampling
 * Input signal frequency: 5 MHz or less
 * Pulse width: 100 ns or more
 * Voltage: Max. 5.5 V, Min. 0 V, and
 TTL level compatible
 * Rise/fall time: 20 ns or less

o TRIGGERING

Trigger mode: Trigger, auto trigger
 Trigger source: CH1, CH2, EXT (AC,DC,DC±10), LINE
 TV trigger: Exclusive sync separator circuit
 provided
 Sensitivity: SYNC signal
 INT: 1 DIV or more
 EXT: 200 mVp-p or more

Trigger sensitivity

* NORM mode:

Frequency	DC to 20 MHz	20 MHz to 100 MHz
INT	0.35 DIV	1.5 DIV
EXT	50 mV	150 mV

* AUTO mode:

Frequency	30 to 100 Hz	100 Hz to 20 MHz	20 to 100 MHz
INT	1.5 DIV	1 DIV	1.5 DIV
EXT	150 mV	100 mV	150 mV

Trigger level
 variable range:

AUTO: Automatically corresponds to
 the trigger signal

NORM:

INT: ±4 DIV or more

EXT: 0.4 V or more

EXT±10: ±4 V or more

Slope:

+, -

External input:

Impedance: 1 MΩ ±5%, 25pF ±6 pF

o READOUT FUNCTION

<<Panel setting display>>

Vertical axis: V/DIV, UNCAL, probe conversion
Sweep speed: S/DIV, UNCAL, MAG (converted value)
Other: Delay time, MAG POINT, PRETRIGGER,
NO. OF SWEEPS

<<Cursor read function>>

Voltage difference

ΔV : Δ -REF
Time difference ΔT : Δ -REF
Frequency $1/\Delta T$: Δ -REF

<<Automatic measuring function>>

Valid only in the STORAGE mode

Difference between

max. and min. voltages: $\pm 5\%$ of the full scale with respect
to the display

Frequency

* Bandwidth: 25 Hz to 100 MHz
* Reference signal
accuracy: $\pm 1\%$

o CURSOR READOUT

Function: Voltage difference ΔV : Δ -REF
Time difference ΔT : Δ -REF
Frequency $1/\Delta T$: Δ -REF

o EXTERNAL OUTPUT

Trigger signal out

* Output voltage: 25 mV/DIV approx.
(Full scale on the CRT)
50-ohm termination
* Frequency response: DC to 10 MHz (-3 dB)
* Output impedance: 50 ohms approx.

o CALIBRATOR

Waveform: 1 kHz $\pm 20\%$, square wave
Voltage: 0.5 V $\pm 1\%$

DIGITAL STORAGE FUNCTIONS

o WAVEFORM DATA STORAGE

Memory capacity: 4000 words/CH x 2
Vertical resolution: 8 bits/10 DIV
Horizontal resolution: 400 data/DIV
Maximum sampling rate:
 VC-6275: 200 Msps, one-channel sampling
 100 Msps, two-channel sampling
 Sampling rate depends on the time
 range. (400 sample/DIV, but 200
 sample/DIV at the two-channel
 sampling at the 2 μ s/DIV range)
 VC-6175: 100 Msps, two-channel sampling
 Sampling rate depends on the time
 range. (400 sample/DIV, but 200
 sample/DIV at the the 2 μ s/DIV range)
 VC-6075: 50 Msps, two-channel sampling
 Sampling rate depends on the time
 range. (400 sample/DIV, but 200
 sample/DIV at the 5 μ s/DIV range,
 100 sample/DIV at the 2 μ s /DIV)

Maximum storage frequency

* A single-shot signal (Maximum amplitude error: 30% or less)

 VC-6275: 25 MHz
 VC-6175: 25 MHz
 VC-6075: 12.5 MHz

* A repetitive signal: 100 MHz
(Three models)

o DATA ACQUISITION

NORM storage mode: Updates a picture on the CRT at each triggering.

AVG mode: Averages input signals by the selected number of sweeps and displays the result after the averaging has reached the selected number.

(Number of average: 2^n , maximum
 2^8 (256))

ENV mode: Displays the envelope of an amplitude modulated waveform. It is possible to detect a pulse whose width is more than 100 ns.

HOLD mode: Holds the waveform displayed on the CRT.

SINGLE sweep: Performs an operation of the NORM storage, AVG, or ENV mode once at each pressing of the SINGLE switch in the HOLD mode, and updates a picture.

ROLL mode: Shifts data from right to left continuously on the CRT. (The updating point is the right end.)

o DATA SAVE

Instrument: Up to two waveforms of CH1, CH2 or ADD can be saved. One or two of the stored waveforms can be displayed on the CRT. (In the AVG mode, the saved data is destroyed.)

IC memory card: Up to 15 waveforms of CH1, CH2 or ADD. One or two of the stored waveforms can be displayed on the CRT.

o PRETRIGGER: 0 to 9.9 DIV variable (in 0.1 DIV steps)

o DATA OUTPUT

Analog PLOT output

- * Y axis output: 2 channels (Y-T output)
1 channel (X-Y output)
1 V/DIV ± 0.100 mV
- * Output for X-Y recorder:
 - X axis output: 1 channel, 1 V/DIV ± 100 mV
 - Output time (X and Y): 1, 2, 5, and 10 s $\pm 5\%$ /DIV
(4-step switching)
 - Load resistance: 2 k Ω or more
(X and Y)
 - Pen lift output: TTL negative, fan out 1
- * Digital PLOT output: For HP-GL
According to GPIB

o DIGITAL OUTPUT

Provides data through GPIB.

- Data: Measurement conditions and waveform
- Measurement conditions: Vertical mode, Horizontal mode, TIME/DIV, probe factor, VOLTS/DIV, pretrigger, delay, etc.
- Waveform: Decimal progression ASCII system or binary system

o MAGNIFYING DISPLAY

A HOLD waveform display after storage can be magnified up to 100 times in conjunction with the TIME/DIV switch.

- ALT MAG: An initial and a magnified waveforms can be displayed simultaneously.

o BATTERY BACK-UP:

Only a save and a work memories can be backed up for approx. 72 hours.

o **POWER SUPPLY**

Voltage: 90 V to 250 V AC
Frequency: 48 to 440 Hz
Power consumption: 120 W approx.

o **ENVIRONMENT**

Operating temperature: 0 to 40 °C
Operating humidity: 45 to 85%
Specification guaranteed
temperature: 10 to 35°C
Safe storage temperature: -20 to +70°C
Safe storage humidity: 35 to 85% (70% or less in the
temperature of 50°C)

o **DIMENSIONS AND WEIGHT**

Dimensions: 330(W) x 160(H) x 450(D) mm
approx.
(13.0(W) x 6.3(H) x 17.7(D) in.
approx.)
Weight: 11 kg approx. (24.2 lb. approx.)